

UNITED STATES
DEPARTMENT OF THE INTERIOR
BUREAU OF LAND MANAGEMENT
Tillamook Field Office
4610 Third Street
Tillamook, Oregon 97141

Silver Lining Timber Sale
ORN04-TS-2019.0402
Date: July 23, 2019

PROSPECTUS

THIS IS A PROSPECTUS ONLY. ATTACHMENTS MAY NOT INCLUDE ALL EXHIBITS REFERRED TO IN THE CONTRACT. THE COMPLETE CONTRACT, INCLUDING ALL EXHIBITS, IS AVAILABLE FOR INSPECTION AT THE TILLAMOOK FIELD OFFICE.

NOTICE IS HEREBY GIVEN that the Bureau of Land Management will offer for sale timber as described herein for oral auction, pursuant to Instructions to Bidders, as stated on Form No. 5440-9, attached. Written and oral bids will be received by the District Manager, or his representative, in the timber sale room at the District Office, 1717 Fabry Road, S.E., Salem, Oregon. Written bids and deposits will be accepted beginning at 8:30 a.m. and the timber sale oral auction will commence at 9:00 a.m., on Wednesday, August 21, 2019.

THIS TIMBER SALE NOTICE does not constitute the decision document for purposes of protest and appeal of a forest management decision. Consistent with 43 CFR Subpart 5003-Administrative Remedies, the notice of a timber sale, when published as a legal ad in a newspaper of general circulation shall constitute the decision document for purposes of protest and appeal. Protests may be filed with the Contracting Officer within 15 days of the publication of the aforementioned decision document in the newspaper. It is anticipated that the decision document will be published in the News-Register on or about July 23, 2019. BLM does not warrant publication on this exact date. All parties considering protest of the timber sale decision document are encouraged to review the aforementioned newspaper(s) to ensure accurate knowledge of the exact publication date.

AN ENVIRONMENTAL ASSESSMENT was prepared for each timber sale tract, and a Finding of No Significant Impact has been documented. These documents are available for inspection as background for each timber sale tract at the Tillamook Field Office.

A WRITTEN BID on Form 5440-9 at not less than the advertised appraised price on a unit basis per species and the required minimum bid deposit shall be required to participate in oral bidding.

THE SUCCESSFUL BIDDER, as a condition of award, will be required to sign Form 5430-11, a certification that the bid was arrived at by the bidder or offeror independently, and was tendered without collusion with any other bidder or offeror. Also, Form 5450-17, Export Determination must be completed by the successful bidder. To expedite procedure, this form should be completed and submitted with the written bid.

THE VOLUMES LISTED herein are estimates only. The sale volumes listed are based on 16-foot taper breaks which must be taken into consideration if comparisons are made with volume predictions based on other standards. The volumes based on 32-foot taper breaks are shown for comparison purposes. No sale shall be made for less than the advertised appraised price. The Purchaser shall be liable for the total purchase price, without regard to the amount bid per unit, even though the quantity of timber actually cut or removed or designated for taking is more or less than the estimated volume or quantity so listed.

THIS TIMBER SALE has been cruised based upon Eastside Scribner board foot measure. The minimum bid figures shown by species are dollars per thousand board feet (MBF). The minimum bid increment will be \$0.10 per MBF.

A PERFORMANCE BOND in an amount not less than 20 percent of the total purchase price will be required for all contracts of \$2,500 or more. A minimum performance bond of not less than \$500 will be required for all installment contracts less than \$2,500.

QUALIFIED SMALL BUSINESS concerns may apply to SBA for a loan to provide financing for access road construction required under the terms of qualifying timber sale contracts, and necessary contract changes will be made. Approval of loan applications rests with SBA and may be contingent on availability of funds. Applicants for such loans shall notify BLM of their intention to apply for a loan.

PRE-AWARD QUALIFICATIONS. The high bidder may be required to furnish information to determine the ability to perform the obligations of the contract. If the high bidder is determined not qualified, responsible or refuses to respond within fifteen (15) days of a request for information pertaining to qualifications, the contract may be offered and awarded for the amount of the high bid to the highest of the bidders who is qualified, responsible, and willing to accept the contract.

LOG EXPORT AND SUBSTITUTION: All timber sales, including timber from Federal rights-of-ways, shall be subject to the restrictions relating to the export and substitution of unprocessed timber from the United States in accordance with P.L. 94-165 and 43 CFR 5400 and 5420, as amended.

LOG EXPORT AND SUBSTITUTION RESTRICTIONS: Excepting Port-Orford-cedar, all timber offered for sale hereunder is restricted from export from the United States in the form of unprocessed timber and is prohibited from being used as a substitute for exported private timber. The BLM has revised the log export restrictions special provision to reduce the log branding and painting requirements. The new requirements include branding of one end of all logs with a scaling diameter of over 10 inches. All loads of 11 logs or more, regardless of the diameter of the logs, will have a minimum of 10 logs branded on one end. All logs will be branded on loads of 10 logs or less. One end of all branded logs will be marked with yellow paint. At the discretion of the Contracting Officer, the Purchaser may be required to brand and paint all logs. The Purchaser shall bear any increased costs for log branding and painting.

CONTRACT MODIFICATION, SUSPENSION OR TERMINATION: A revised Special Provision has been added to the contract which enables the Contracting Officer to suspend the contract to facilitate protection of certain plant or animal species, and/or to modify or terminate the contract when necessary to: (1) Comply with the Endangered Species Act or to prevent incidental take of northern spotted owls in accordance with management direction in the Record of Decision (ROD) and Resource Management Plan (RMP), or; (2) Comply with a court order, or; (3) Protect species which were identified for protection through survey and manage and/or protection buffer standards and guidelines or management direction established in the ROD and RMP.

ADDITIONAL INFORMATION concerning this timber sale tract is available at the above District Office. A copy of the timber sale contract is also available for inspection at the District Office. The prospectus for this/these sale(s) is also available online at: <https://www.blm.gov/or/resources/forests/index.php>. The prospectus includes maps and tables that cannot be made Section 508 compliant. For help with its data or information, please contact the Tillamook Field Office at 503-815-1100.

Attachments:
Form 5450-17
Form 5430-11
Form 5440-9

TIMBER SALE NOTICE

THIS IS A SCALE SALE

NORTHWEST OREGON DISTRICT
TILLAMOOK FIELD OFFICE
COLUMBIA MASTER UNIT

Sale Date: August 21, 2019

CONTRACT NO.: ORN04-TS-2019.0402, SILVER LINING

YAMHILL COUNTY, OREGON: O&C: ORAL AUCTION: BID DEPOSIT REQUIRED: \$196,200.00

All timber designated for cutting on W $\frac{1}{2}$ NE $\frac{1}{4}$, SE $\frac{1}{4}$ NE $\frac{1}{4}$, E $\frac{1}{2}$ NW $\frac{1}{4}$, SW $\frac{1}{4}$ NW $\frac{1}{4}$, N $\frac{1}{2}$ SW $\frac{1}{4}$, SE $\frac{1}{4}$; Section 19; W $\frac{1}{2}$ NE $\frac{1}{4}$, NW $\frac{1}{4}$, NE $\frac{1}{4}$ SW $\frac{1}{4}$, NW $\frac{1}{4}$ SE $\frac{1}{4}$; Section 29, T. 3 S., R. 5 W, WM.

THIS TIMBER SALE HAS BEEN CRUISED BASED UPON EASTSIDE SCRIBNER MEASURE.

Minimum bid figures shown by species are dollars per thousand board feet (MBF). The minimum bid increment will be \$0.10 per MBF.

Approx. No. Merchantable Trees	Est. Vol. MBF 32' Log	Species	Est. Vol. MBF 16' Log	Appraised Price Per MBF	Estimated Volume Times Appraised Price
31,814	6,560	Douglas-fir	8,155	\$221.30	\$1,804,701.50
689	294	western redcedar	370	\$403.20	\$149,184.00
827	50	bigleaf maple	63	\$39.30	\$2,475.90
144	22	grand fir	26	\$105.30	\$2,737.80
196	16	western hemlock	20	\$84.70	\$1,694.00
86	4	red alder	5	\$69.60	\$348.00
33,756	6,946		8,639		\$1,961,141.20

Product	Unit of Measure	Estimated Number of Units	Appraised Price per Unit	Estimated Volume Times Appraised Price
Marginal Logs	Green Tons	135	\$5.00	\$675.00
		135		\$675.00

Total Appraised Value:	\$1,961,816.20
-------------------------------	-----------------------

LOG EXPORT AND SUBSTITUTION RESTRICTIONS: All timber offered for sale hereunder is restricted from export from the United States in the form of unprocessed timber and also prohibited from substitution of exported private timber.

CRUISE INFORMATION: The timber volumes for the partial cut units were based on a variable plot cruise for estimating the board foot volume of trees. Plots were measured using a 20 basal area factor (BAF) for partial cut units and a 40 BAF for regeneration harvest units and new construct roads. Board foot volume estimates for renovate roads is based on a 100% cruise. None of the total sale volume is salvage material. For merchantable Douglas-fir trees the average DBHOB is 15.5 inches; the average gross merchantable log contains 75 bf; the total gross volume is approximately 8,442 MBF; and 93% recovery is expected.

CUTTING AREA: Three (3) units totaling approximately two hundred ninety-seven (297) acres, of which one hundred twenty-six (126) acres shall be regeneration harvest and one hundred sixty-six (166) acres shall be partial cut harvest. In addition, approximately five (5) acres of right-of-way shall be cut. Acres shown on Exhibit A have been computed using an S1 mobile mapper and Trimble R1 GNSS Receiver.

DURATION OF CONTRACT: Contract length will be thirty-six (36) months for cutting and removal of timber.

ADDITIONAL INFORMATION: This contract includes an additional special provision to ensure the Purchaser understands he/she is required to conduct all operations in compliance with Contract Section 12 (Purchaser's Contractual Responsibilities for Liability) and Contract Section 29 (Safety and Health) and the Special Provisions included in Section 42 of this Contract.

SPECIAL ATTENTION ITEMS:

Sec. 42.i. Bridge maintenance on Rex Brown Road

Sec. 42.dd. Creation of Coarse Woody Debris

OPTIONAL CONTRIBUTION (Sec. 42.ee.): The Purchaser will have the option of performing Coarse Woody Debris or contributing sixty-five thousand, six hundred ninety-two and 00/100 dollars (\$65,692.00) in lieu thereof. The option must be declared *prior* to contract execution.

LOCATION: The contract area is located approximately 7.5 air miles west of Carlton, Oregon. Starting in Carlton, head west on NW. Meadow Lake Road for 4.2 miles. Turn left and follow NW. Panther Creek Road for 2.8 miles. Turn left and follow Rex Brown Road for 3.2 miles. Make a slight left onto Panther Creek Road and travel 2.8 miles. Turn left and follow NW. Rex Brown Road for 0.6 miles. Turn right onto Brown Road and travel for 0.5 miles where you will encounter Unit 3 of the Silver Lining Timber Sale. Consult a project location map.

ACCESS AND ROAD MAINTENANCE: Access is provided by County and Bureau of Land Management (BLM) controlled roads. All roads used in conjunction with this sale will be maintained by the Purchaser, except for Rex Brown Road, which is County maintained. Purchaser will be required to pay a rockwear obligation of (\$0.60/MBF/Mile of actual timber hauled) to the Government and spread **635 CY** crushed rock on BLM roads for maintenance.

Rockwear fees are based on estimated volumes. Actual fees shall be calculated with the actual volume hauled over said road segments after all merchantable timber has been cut and scaled. If the actual fees differ for what is mentioned and paid above, the additional/difference shall be reported and paid accordingly by "owing party". Purchaser maintenance shall include frequent blading and shaping of road surface; ditch, culvert, and catch basin cleaning; removal of minor slides and other debris. Roads shall be left in a condition to withstand adverse weather at the end of the seasonal operations.

Extended season haul on some roads may be available but will require a contract modification. Contact Engineers at the Tillamook Field Office for more detailed information.

ROAD CONSTRUCTION AND RENOVATION: The Purchaser will be required to do all work set forth below. The Purchaser shall supply all material unless otherwise indicated.

1.

New Road Construction:

- Road Spur A: 325 feet, 14-foot ditched/crowned subgrade, Natural surfacing, Clearing and Grubbing, Landing construction as marked, Spread/Place Spot & Bedding Rock as marked and as directed by rock sheets, Install one culvert as marked, and install one inlet marker as marked.
- Road Spur B: 355 feet, 14-foot ditched/crowned subgrade, Natural surfacing, Clearing and Grubbing, Landing construction as marked, and spread Spot Rock as marked and as directed by rock sheets.
- Road Spur C: 299 feet, 14-foot outsloped subgrade, Natural surfacing, Clearing and Grubbing, Construct turnout, turnaround, and landings as marked, and spread Spot Rock as marked and as directed by rock sheets.
- Road 3-5-19.5: 1,187 feet, 14-foot ditched/crowned subgrade, Natural surfacing, Clearing and Grubbing, Construct turnouts, turnarounds, and waste areas as marked in the field, Construct ditchouts as marked, Spread/Place Rock types and quantities as marked in the field and as directed by rock sheets, Install culverts as marked, and install inlet markers.
- Road 3-5-19.5A: 164 feet, 14-foot ditched/crowned subgrade, Natural surfacing, Clearing and Grubbing, Spread/Place Rock types and quantities as marked in the field and as directed by rock sheets, and install culverts as marked in the field.
- Road 3-5-19.6: 1,457 feet, 14-foot ditched/crowned subgrade, 12-foot surfaced width, Clearing and Grubbing, Construct turnouts, turnarounds, and landings as marked, Spread/Place Rock types and quantities and Rock Lifts as directed by rock sheets, Install culverts as marked in the field, and install inlet markers as marked.
- Road 3-5-19.9: 1,091 feet, 14-foot ditched/crowned subgrade, 12-foot surfaced width, Clearing and Grubbing, Construct turnouts, turnarounds, and landings and marked in the field, Spread/Place Rock types and quantities and Rock Lifts as directed by rock sheets, Install culverts as marked in the field, and install inlet markers as marked.
- Road 3-5-29.4 (Sta. 8+15 – 10+11): 196 feet, 14-foot ditched/crowned subgrade, Natural surfacing, Clearing and Grubbing, and Construct turnouts and landings as marked in the field.
- Road 3-5-29.5: 383 feet, 14-foot outsloped subgrade, Natural surfacing, Clearing and Grubbing, Construct turnaround and landings as marked, and Spread/Place Rock types and quantities as directed by rock sheets.
- Road 3-5-29.6: 515 feet, 14-foot ditched/crowned subgrade, Natural surfacing, Clearing and Grubbing, Construct a waste area as marked in the field, Construct ditchouts as marked, Construct lead-off ditch from culvert outlet, Spread/Place Rock types and quantities as directed by rock sheets, Install culvert as marked in the field, and install inlet marker as marked.
- Road 3-5-29.6: 591 feet, 14-foot outsloped subgrade, Natural surfacing, Clearing and Grubbing, and Construct turnaround and landing as marked in the field.
- Road 3-5-29.7: 1,361 feet, 14-foot ditched/crowned subgrade, Natural surfacing, Clearing and Grubbing, Construct turnouts, turnarounds, waste areas, and landings as marked in the field, Construct ditchouts as marked, Spread/Place Rock types and quantities as directed by rock sheets, Install culverts as marked in the field, and install inlet markers as marked.
- Road 3-5-29.8: 869 feet, 14-foot ditched/crowned subgrade, Natural surfacing, Clearing and Grubbing, Construct turnarounds and landings as marked in the field, Construct lead-off ditch from culvert outlet as marked, Spread/Place Rock types and quantities as directed by rock sheets, Install culverts as marked in the field, and install inlet markers as marked.

2. Renovation:

- Road 3-5-19.1: 5,329 feet, 14-foot ditched/crowned subgrade, 12-foot surfaced width, Blade and Compact Surface, Brushing with some Clearing and Grubbing, Ditchline Re-establishment by bunching and hauling, Construct turnouts, turnarounds, waste areas, French drain, and landings as marked in the field and as directed by Authorized Officer, Construct ditchouts as marked, Spread/Place Rock types and quantities and Rock Lifts as directed by rock sheets, Place Rip-Rap for Slope Armor and Energy Dissipater as marked, Construct 6 sediment catch basins with straw bales in ditchline as marked in the field, Install 3 culverts, Replace 10 culverts, and Install 11 inlet markers as directed by culvert lists.
- Road 3-5-19.7: 1,565 feet, 14-foot ditched/crowned subgrade, Natural surfacing, Blade and Compact Surface, Brushing with some Clearing and Grubbing, Ditchline Re-establishment by bunching and hauling, Construct turnouts, turnarounds, waste areas, and landings as marked in the field, Construct ditchouts as marked, Spread/Place Rock types and quantities as directed by rock sheets, Install 2 culverts, and install 2 inlet markers as directed by culvert lists.
- Road 3-5-19.8 (Sta. 0+00 – 1+27): 127 feet, 14-foot ditched/crowned subgrade, 12-foot surfaced width, Blade and Compact Surface, Brushing with some Clearing and Grubbing, Ditchline Re-establishment by bunching and hauling, Spread/Place Rock types and quantities as directed by rock sheets, and install 1 culvert as directed by culvert lists.
- Road 3-5-19.8 (Sta. 1+27 – 1+70 & 4+19 – 5+41): 165 feet, 14-foot ditched/crowned subgrade, Natural surfacing, Blade and Compact Surface, Brushing with some Clearing and Grubbing, Ditchline Re-establishment by bunching and hauling, Spread/Place Rock types and quantities as directed by rock sheets, Install 1 culvert, and install inlet marker as directed by culvert lists.
- Road 3-5-19.10: 437 feet, 14-foot outsloped subgrade, Natural Surfacing, Blade and Compact Surface, Brushing with some Clearing and Grubbing, Construct turnaround and landing as marked in the field, Spread/Place Rock types and quantities as directed by rock sheets, and install 1 culvert as directed by culvert lists.
- Road 3-5-20.0: 1.956 miles, 14-foot ditched/crowned subgrade, 12-foot surfaced width, Blade and Compact Surface, Brushing with some Clearing and Grubbing, Ditchline Re-establishment by bunching and hauling, Construct turnouts, waste areas, and landings as marked in the field, Construct ditchouts as marked, Spread/Place Rock types and quantities and Rock Lifts as directed by rock sheets, Place Rip-Rap for Slope Armoring and Energy Dissipater, Construct 2' x 2' ditchline with pit-run armoring as marked in the field, Construct 6 sediment catch basins with straw bales as marked in the field, Install 1 culvert, Replace 8 culverts, and install 18 inlet markers as directed by culvert lists.
- Road 3-5-20.1 (Sta. 0+00 - 11+92, 13+26 - 50+14, 52+23 - 66+10, 68+91 - 88+20, 89+85 - 97+69): 8,980 feet, 14-foot ditched/crowned subgrade, 12-foot surfaced width, Blade and Compact Surface, Brushing with some Clearing and Grubbing, Ditchline Re-establishment by bunching and hauling, Construct turnouts, turnarounds, waste areas, French drain, and landings as marked in the field, Construct ditchouts as marked, Spread/Place Rock types and quantities and Rock Lifts as directed by rock sheets, Place Rip-Rap for Slope Armoring as marked, Remove slide material from Sta. 40+48 – 41+00 and haul to waste area as marked, Construct 5 sediment catch basins with straw bale as marked, Install 8 culverts, Replace 3 culverts, Replace 1 downspout, and install 18 inlet markers as directed by culvert lists.
- Road 3-5-20.1 (Sta. 66+10 – 68+91, 88+20 – 89+85): 446 feet, 14-foot outsloped subgrade, 12-foot surfaced width, Blasé and Compact Surface, Brushing with some Clearing and Grubbing, and Spread Rock Lifts as directed by rock sheets.

Road 3-5-29.0: 632 feet, 14-foot ditched/crowned subgrade, 12-foot surfaced width, Blade and Compact Surface, Brushing with some Clearing and Grubbing, Ditchline Re-establishment by bunching and hauling, Construct a waste area as marked in the field, Construct ditchouts as marked, Spread/Place Rock types and quantities as directed by rock sheets, Replace 2 culverts, and install 1 inlet marker as directed by culvert lists.

Road 3-5-29.3: 842 feet, 14-foot ditched/crowned subgrade, 12-foot surfaced width, Blade and Compact Surface, Brushing with some Clearing and Grubbing, Ditchline Re-establishment by bunching and hauling, Construct turnaround and landings as marked in the field, Spread/Place Rock types and quantities as directed by rock sheets, Place Rip-Rap for slope armoring as marked, Install 2 culverts, Replace 1 culvert, and install 1 inlet marker as directed by culvert lists.

Road 3-5-29.4 (Sta. 0+00 – 8+15): 815 feet, 14-foot ditched/crowned subgrade, 12-foot surfaced width, Blade and Compact Surface, Brushing with some Clearing and Grubbing, Ditchline Re-establishment by bunching and hauling, Construct a turnaround as marked in the field, Spread/Place Rock types and quantities as directed by rock sheets, Construct 1 sediment catch basin with a straw bale in ditchline as marked, Install 1 culvert, Replace 1 culvert, and install 3 inlet markers as directed by culvert lists.

Road Rex Brown Road: 0.587 miles, 18-foot ditched crowned subgrade, 16-foot surfaced width, Blade and Compact Surface, Clearing and Grubbing, Ditchline Re-establishment by bunching and hauling, Construct ditchouts as marked in the field, Spread/Place Rock types and quantities as directed by rock sheets, Construct 2 sediment catch basins with straw bales in ditchlines as marked, Replace 1 culvert, Re-use 1 inlet marker as directed by culvert lists.

3. Improvement:

Road 3-5-19.8 (Sta. 1+70 – 4+19): 249 feet, 14-ditched/crowned subgrade, Natural surfacing, Blade and Compact Surface, Clearing and Grubbing, and Construct a turnaround as marked in the field.

Road 3-5-20.1 (Sta. 11+92 – 13+26, 50+14 – 52+23): 343 feet, 14-foot ditched/crowned subgrade, 12-foot surfaced width, Blade and Compact Surface, Clearing and Grubbing, Spread/Place Rock types and quantities and Rock Lifts as directed by rock sheets, Place Rip-Rap for Slope Armoring as marked, Construct 1 sediment catch basin with straw bale in ditchline as marked, Replace 1 culvert, and install 1 inlet marker as directed by culvert lists.

4. Estimated Quantities:

a. Clearing, Grubbing, and Brushing:

11.0 acres of Clearing and Grubbing
4.156 miles of Brushing

b. Culverts:

2,460 feet of 18 inch Corrugated Plastic Pipe (CPP) – Type S
20 feet of 18 inch Corrugated Plastic Pipe (CPP) – Type C
36 feet of 24 inch Corrugated Plastic Pipe (CPP) – Type S
437 feet of 36 inch Corrugated Plastic Pipe (CPP) – Type S
88 feet of 24 inch 12 gage Aluminized Steel Pipe (CMP)
74 feet of 42 inch 14 gage Aluminized Steel Pipe (CMP)
50 feet of 48 inch 14 gage Aluminized Steel Pipe (CMP)
52 feet of 73” x 55” 12 gage Aluminized Steel Arch Pipe (CMP)
69 Metal “T” Posts for Inlet Markers

c. Aggregate & Asphalt Material:

<u>Quantity</u>	<u>Description</u>
5,419 cubic yards	1-1/2" minus crushed rock – construction rock
4,153 cubic yards	3" minus crushed rock – construction rock
75 cubic yards	Pit-Run – construction rock
280 cubic yards	1-1/2" – 3/4" crushed drain rock – construction rock
1,460 cubic yards	1-1/2" minus crushed rock - Culvert bedding material
635 cubic yards	1-1/2" minus crushed rock – BLM Maintenance rock
320 cubic yards	Riprap – (Class 3)
190 cubic yards	Riprap – (Class 5)

Rock Source: 1-1/2" minus crushed rock, 1-1/2"-3/4" drain rock and Pit-Run rock – Laurelwood Quarry. 3" minus crushed rock – Stephens Quarry. Riprap Class 3 and Class 5 – DK Quarry.

OTHER:

Compaction of all final grades will be required.

Right of way debris will be disposed of by scattering adjacent to all roads, outside of clearing limits.

All roads shall be decommissioned as follows:

The Purchaser shall decommission roads 3-5-19.5, 3-5-19.5A, 3-5-19.7, and 3-5-29.8, as shown on Exhibit C, by subsoiling, installing non-drivable waterbars, scattering slash, removing culverts, and blocking.

Purchaser shall decommission roads Spur A and Spur B as shown on Exhibit C, by installing non-drivable waterbars, scattering slash, removing culverts, and blocking.

Purchaser shall decommission roads 3-5-19.6, 3-5-19.9, 3-5-19.10, 3-5-29.5, 3-5-29.6, 3-5-29.7, and Spur C, as shown on Exhibit C, by installing non-drivable waterbars, and blocking.

Grass seeding will be required on all newly disturbed areas. Grass seed will be furnished by the Government.

Straw mulch will be required on all disturbed/seeded soils that are wet and/or within 50 feet each side of "live stream" locations and all disposal sites. Grass straw will be furnished by the Government.

All waste from re-establishing ditchlines on rock surfaced roads shall be bunched and end-hauled to designated waste areas.

All slide removal material shall be end-hauled to designated waste areas.

All culverts removed upon road decommissioning shall be salvaged and delivered to the BLM Maintenance Facility at the SW¼ of Section 5, T. 3 S., R. 6 W., WM.

Water required for processing rock shall be obtained at the McMinnville Water & Light's Haskins Creek Reservoir Facility, or from other locations approved in writing by the Authorized Officer and according to the applicable STATE water regulations and sites indicated. The Purchaser shall enter into an agreement with McMinnville Water and Light and meet said requirements. It is estimated that approximately two hundred forty one thousand gallons (241,000) will be required.

TIMBER SALE CONTRACT SPECIAL PROVISIONS

Sec. 41. Timber and Area Reservation Provisions

RESERVED

- a. All timber in the reserve area(s) shown on Exhibit A, and all trees that are painted orange and/or posted, which mark the boundaries of the sale areas.
- b. All trees marked with orange paint above and below stump height within the boundaries of the sale areas shown on Exhibit A.
- c. All trees within areas posted as Leave Islands, which are shown as reserve areas within the harvest units on Exhibit A.
- d. All trees within twenty-five (25) feet of seeps, springs, or wetlands.
- e. All trees required to meet residual tree requirements set forth in Exhibit F Designation by Prescription, which is attached hereto and made a part hereof.
- f. Western redcedar or western hemlock trees less than eight (8) inches diameter at breast height (Dbh), Pacific madrone, Pacific dogwood, and snags in the sale areas shown on Exhibit A, outside of posted Rights-of-Ways, which do not present a safety hazard as determined by the Authorized Officer. If any are felled, they shall be retained on site.
- g. All trees forty (40) inches Dbh and larger in the Sale Areas shown on Exhibit A.
- h. Existing down logs in the sale areas shown on Exhibit A, which do not present a safety hazard as determined by the Authorized Officer.
- i. Trees felled within road rights-of-way, which are marked with yellow paint above and below stump height, shall remain on site and be placed outside of the road prism, and are not included in the timber sale.

Sec. 42. Special Provisions

LOGGING

- a. Before beginning operations on the Contract Area for the first time or after a shutdown of seven (7) or more days, the Purchaser shall notify the Authorized Officer in writing of the date they plan to begin operations. This written notification must be received by the Authorized Officer no less than seven (7) days prior to the date the Purchaser plans to begin or resume operations. The Purchaser shall also notify the Authorized Officer in writing if they intend to cease operations for any period of seven (7) or more days.

b. Prior to the commencement of operations, the Purchaser shall obtain from the Authorized Officer approval of a written operations and logging plan commensurate with the terms and conditions of the contract which shall include measures needed to assure protection of the environment and watershed. A pre-work conference between the Purchaser's authorized representative and the Authorized Officer must be held before the logging plan will be approved. All logging shall be done in accordance with the approved logging plan. The Purchaser shall provide a minimum of seven (7) days notice when requesting the scheduling of a pre-work conference.

c. Excessive damage to reserve timber, as determined by the Authorized Officer, will result in suspension of yarding operations until corrective measures to prevent further damages have been approved by the Authorized Officer.

d. No falling, yarding, or loading is permitted in or through the reserve area or across cutting area boundaries shown on Exhibit A, unless otherwise approved by the Authorized Officer.

e. Prior to attaching any logging equipment to a reserve tree, the Purchaser shall obtain approval from the Authorized Officer, and shall take precautions to protect the tree from damage as directed by the Authorized Officer.

f. All trees designated for cutting shall be cut so that the resulting stumps shall not be higher than twelve (12) inches measured from the ground on the uphill side of the trees unless otherwise approved by the Authorized Officer.

g. All hardwoods eight (8) inches or larger Dbh in the sale areas shown on Exhibit A, which are not reserved, shall be felled and removed from the sale area.

h. At all landings in the sale area, all non-merchantable logs more than eight (8) inches in diameter at the large end and exceeding eight (8) feet in length shall be removed from the sale area as directed by the Authorized Officer.

i. Prior to haul across the Panther Creek Bridge on Rex Brown Road, the Purchaser shall plug the bridge scuppers (drain holes) and sweep the bridge surface. After haul is complete and before the fall wet season begins, the Purchaser shall sweep the bridge surface again and unplug the bridge scuppers (drain holes).

j. Tracked type equipment shall not be allowed to cross over concrete bridge decks, other concrete surfaced structures, or asphalt surfaced roads without the proper protection of that surface. Prior approval shall be obtained from the Authorized Officer when crossing with protective devices.

k. In all harvest areas shown on Exhibit A, except where ground-based yarding is allowed in Sec. 42.1., all yarding shall be done with a skyline or similar cable system equipped with a slack pulling carriage capable of transporting logs completely clear of the ground and capable of yarding one thousand (1,000) feet slope distance from the landing and at least seventy-five (75) feet laterally from the skyline to the designated sky road and with minimum damage to reserved trees. The carriage shall be capable of being held in position on the skyline during all lateral yarding and shall be able to pass intermediate support jacks as required.

The leading end of all logs shall be transported free of the ground during yarding. Full suspension is required within fifty (50) feet of streams. The rigging of tail or lift trees, intermediate supports and use of tail holds outside the Sale Areas shall be required where necessary to meet this requirement. If trees are cut within a no harvest stream buffer for operational purposes, they will remain on site and will be felled away from the stream unless otherwise directed by the Authorized Officer. Skyline corridors in partial cut areas shall not exceed fifteen (15) feet in width and have an average spacing of one hundred fifty (150) feet.

l. Ground-based operations are limited to slopes of thirty-five (35) percent or less. All skidding shall be done by equipment operated entirely on skid trails that have been approved by the Authorized Officer and use existing skid trails as much as possible. Harvest equipment operating off of approved skid trails shall use the minimum number of passes necessary. The area composed of skid trails shall not exceed fifteen (15) percent of the total yarding area within a unit. Excavation on designated skid trails shall be limited to a maximum cut of one (1) foot unless otherwise approved by the Authorized Officer. The Purchaser shall directionally fall trees into the lead with the skidding direction and winch or carry the logs to the skid trails. Temporary logging roads, skid trails, and harvester/forwarder trails would be water barred and blocked as directed by the Authorized Officer, after each operating season before the fall wet season begins.

m. Before cutting and removing any trees necessary to facilitate logging in the Harvest Areas shown on Exhibit A, the Purchaser shall identify the location of skid trails, cable yarding roads, and tail hold, tieback, guy line, lift, intermediate support, and danger trees on the ground in a manner approved by the Authorized Officer at the pre-work conference, and documented in the Logging Plan. Said Purchaser identification of trees to be cut and removed does not constitute authority to proceed with cutting and removal. In addition, before proceeding the following conditions must be met:

1. All skid trails and/or cable yarding roads upon which timber is identified by the Purchaser to be cut and removed in accordance with this special provision must be necessary for the safe and expeditious removal of timber sold under this contact and shall be limited to the minimum width necessary for yarding of logs with a minimum of damage to reserve trees.

2. The Purchaser may immediately cut and remove additional timber to clear skid trails and cable yarding roads; and provide tail hold, tieback, guy line, lift and intermediate support trees when the trees have been marked with blue or green paint above and below stump height by the Authorized Officer and thereby approved for cutting and removal by the Authorized Officer. When trees are marked with yellow paint above and below stump height they may be cut, but must remain on site.

SAFETY

n. Purchaser's operations shall facilitate BLM's safe and practical inspection of Purchaser's operations and BLM's conduct of other official duties on Contract Area. Purchaser has all responsibility for compliance with safety requirements for Purchaser's employees, contractors, and subcontractors.

In the event that the Authorized Officer identifies a conflict between the requirements of this contract or agreed upon methods of proceeding hereunder and State or Federal safety requirements, the contract may be modified. If the cost of such contract modification is of a substantial nature (\$2,000.00 or more), the Purchaser may request, in writing, an adjustment in the Total Purchase Price specified in Sec. 2. of the timber sale contract, as amended, to compensate for the changed conditions.

Unless otherwise specified in writing, when operations are in progress adjacent to or on roads and/or trails in the harvest unit area, the Purchaser shall furnish, install, and maintain all temporary traffic controls that provide the road or trail user with adequate warning of and protection from hazardous or potentially hazardous conditions associated with its operations. Purchaser shall prepare a Traffic Control Plan, which the Purchaser has determined is compliant with state and local OSHA and Transportation standards no later than the pre-work meeting and prior to commencing operations. Traffic control devices shall be appropriate to current operating and/or weather conditions and shall be covered or removed when not needed. Flagmen and devices shall be as specified in state OSHA and Transportation standards for logging roads or the "Manual on Uniform Traffic Control Devices for Streets and Highways" (MUTCD) published by the U.S. Department of Transportation - Federal Highway Administration. Included in the Traffic Control Plan, Purchaser shall note traffic control device locations on a Purchaser-produced copy of the contract Exhibit A Map.

SEASONAL RESTRICTIONS

o. No mechanized falling or ground based yarding shall be conducted in the Sale Areas shown on Exhibit A outside of dry season (generally October 16 of one calendar year to May 31 of the following calendar year). If conditions are sufficiently dry, as determined by the Authorized Officer, some of these activities may be allowed during the seasonal restriction.

p. No cable yarding or haul except from Von Road (3-5-20.0), Panther Creek Road, 3-5-19.1, 3-5-19.6, 3-5-19.8, and 3-5-19.9 in the Sale Areas shown on Exhibit A outside of dry season (generally October 16 of one calendar year to May 31 of the following calendar year).

If conditions are sufficiently dry, as determined by the Authorized Officer, some of these activities may be allowed during the seasonal restriction.

q. No road renovation, road construction, road improvement, road decommissioning or stabilization, sub-soiling, or road maintenance shown on Exhibits C, D, or E during times when there is a high potential to deliver sediment to streams or as otherwise directed by the Authorized Officer.

r. No work required in live streams shall be conducted between October 1 of one calendar year and July 14 of the following calendar year, both days inclusive, unless BLM receives a waiver from the Oregon Department of Fish and Wildlife.

ROAD CONSTRUCTION, IMPROVEMENT, RENOVATION, MAINTENANCE AND USE

s. The Purchaser shall construct natural surfaced roads: 3-5-19.5, 3-5-19.5A, 3-5-29.4 (Sta. 8+15 – 10+11), 3-5-29.5, 3-5-29.6, 3-5-29.7, 3-5-29.8, Spur A, Spur B, and Spur C. The Purchaser shall construct surfaced roads: 3-5-19.6 and 3-5-19.9. The Purchaser shall renovate surfaced roads: Rex Brown Road, 3-5-20.0, 3-5-19.1, 3-5-19.8 (Sta. 0+00 – 1+27), 3-5-20.1 (Sta. 0+00 – 11+92 & 13+26 – 50+14 & 52+23 -97+69), 3-5-29.0, 3-5-29.3, and 3-5-29.4 (Sta. 0+00 – 8+15). The Purchaser shall renovate natural surfaced roads: 3-5-19.7, 3-5-19.8 (Sta. 1+27 – 1+70, 4+19 – 5+41), and 3-5-19.10. The Purchaser shall improve natural surfaced roads: 3-5-19.8 (Sta. 1+70 – 4+19). Construction, renovation, and improvement shall be done in strict accordance with the plans and specifications shown on Exhibit C, which is attached hereto and made a part hereof.

t. Any required construction, renovation, and improvement of roads shall be completed and accepted prior to the removal of any timber, except right-of-way timber, over that road.

u. The Purchaser shall decommission roads 3-5-19.5, 3-5-19.5A, 3-5-19.7, and 3-5-29.8, as shown on Exhibit C, by subsoiling, installing non-drivable waterbars, scattering slash, removing culverts, and blocking. Purchaser shall decommission roads Spur A and Spur B as shown on Exhibit C, by installing non-drivable waterbars, scattering slash, removing culverts, and blocking. Purchaser shall decommission roads 3-5-19.6, 3-5-19.9, 3-5-19.10, 3-5-29.5, 3-5-29.6, 3-5-29.7, and Spur C, as shown on Exhibit C, by installing non-drivable waterbars, and blocking. Subsoiling shall consist of loosening the soil to a depth of eighteen (18) inches utilizing excavator attachments, log loader tongs or other approved equipment acceptable to the Authorized Officer. No subsoiling shall be required where the road traverses rock outcroppings. All natural water courses shall be opened to prevent erosion of the road. Barriers shall be constructed and clearing debris shall be placed on and around the barriers so as to prevent further use of the road by vehicles as shown on Exhibit C. Decommissioning and stabilization shall be completed within thirty (30) days of completion of yarding and hauling operations on that road.

v. The Purchaser is authorized to use the roads listed below and shown on Exhibit E for the removal of Government timber sold and rock hauled under the terms of this contract, provided that the Purchaser pay the rockwear obligations described in section 42.w. Any road shown on Exhibit E and requiring improvement, renovation, or construction in Exhibit C of this contract, shall be maintained by the Purchaser until receiving written acceptance of the improvement, renovation, or construction from the Contracting Officer. The Purchaser shall pay current Bureau of Land Management rockwear fees for the sale of additional timber under modification to the contract.

Road No. and Segment	Length Used (Miles)	Road Control	Road Surface Type	Maintenance Responsibility
Spur A	0.062	BLM	Natural	Purchaser
Spur B	0.067	BLM	Natural	Purchaser
Spur C	0.057	BLM	Natural	Purchaser
3-5-19.1	1.009	BLM	Rocked	Purchaser
3-5-19.5	0.225	BLM	Natural	Purchaser
3-5-19.5A	0.031	BLM	Natural	Purchaser
3-5-19.6	0.276	BLM	Rocked	Purchaser
3-5-19.7	0.296	BLM	Natural	Purchaser
3-5-19.8 (Seg. A1)	0.024	BLM	Rocked	Purchaser
3-5-19.8 (Seg. A2)	0.078	BLM	Natural	Purchaser
3-5-19.9	0.207	BLM	Rocked	Purchaser
3-5-19.10	0.083	BLM	Natural	Purchaser
3-5-20.1	1.850	BLM	Rocked	Purchaser
3-5-29.0	0.120	BLM	Rocked	Purchaser
3-5-29.3	0.159	BLM	Rocked	Purchaser
3-5-29.4	0.191	BLM	Rocked	Purchaser
3-5-29.5	0.073	BLM	Natural	Purchaser
3-5-29.6	0.209	BLM	Natural	Purchaser
3-5-29.7	0.258	BLM	Natural	Purchaser
3-5-29.8	0.165	BLM	Natural	Purchaser
3-5-20.0 (Seg. A-C3)	1.816	BLM	Rocked	Purchaser

w. The Purchaser shall pay a rockwear fee of sixty cents (\$0.60) per thousand board feet log scale, per mile, for the use of roads. The total rockwear fee due shall be based upon volumes determined pursuant to Exhibit B of this contract and mileage or roads used as determined by the Authorized Officer. Prior to the use of such roads, the Purchaser shall give written notice to the Authorized Officer of the roads intended for use in the removal of timber purchased under this contract, together with an estimate of the volume to be hauled over such roads.

If it is determined by the Authorized Officer, after all merchantable timber has been cut and scaled, that the total rockwear payments made under this contract exceed the total rockwear payment due, such excess shall be returned to the Purchaser after such determination is made.

x. The Purchaser shall perform any required road repair and maintenance work on roads used, under the terms of Exhibit D “Road Maintenance Specifications” and Exhibit E “Maintenance and Access Maps”, and deemed as Purchaser Maintenance in Section 42.v. of this contract, which is attached hereto and made a part thereof. Purchaser shall spread six hundred thirty-five (**635**) cubic yards of spot rock on BLM roads and BLM controlled roads used for this timber sale, as directed by Authorized Officer as part of maintenance requirements.

ENVIRONMENTAL PROTECTION

y. In order to prevent the spread of noxious weeds, the Purchaser shall pressure wash all road construction and ground based logging equipment that will be used off of existing roads, as well as loaders and mechanically propelled brush cutters, prior to entry onto the BLM Land shown on Exhibit A, as directed by the Authorized Officer. Cleaning shall be defined as removal of all dirt, grease, plant parts and material that may carry noxious weed seeds.

z. The Purchaser shall immediately discontinue specified construction or harvesting operations upon written notice from the Contracting Officer that:

1. threatened or endangered plants or animals protected under the Endangered Species Act of 1973, as amended, may be affected by the operation, and a determination is made that consultation or reinitiation of consultation is required concerning the species prior to continuing operation, or;
2. when, in order to comply with the Endangered Species Act, or to prevent incidental take of northern spotted owls in accordance with management direction in the Record of Decision (ROD) and Resource Management Plan (RMP), or to protect occupied marbled murrelet sites in accordance with management direction of the ROD and RMP, the Contracting Officer determines it may be necessary to modify or terminate the contract, or;
3. federal proposed, federal candidate, Bureau sensitive or State listed species protected under BLM Manual 6840 - Special Status Species Management - have been identified, and a determination is made that continued operations would affect the species or its habitat, or;
4. when, in order to comply with a court order, which enjoins operations on the sale or otherwise requires the Bureau of Land Management to suspend operations, or;
5. when, in order to comply with a court order, the Contracting Officer determines it may be necessary to modify or terminate the contract, or;
6. species have been discovered which were identified for protection in accordance with management direction established in the ROD and RMP, and the Contracting Officer determines that continued operations would affect the species or its habitat, or;
7. when, in order to protect species which were identified for protection in accordance with management direction established in the ROD and RMP, the Contracting Officer determines it may be necessary to modify or terminate the contract.

Those operations necessary for a safe removal of personnel and equipment from the contract area and those directed by the Contracting Officer, which are required in order to leave the contract area in an acceptable condition will be permitted. Discontinued operations may be resumed upon receipt of written instructions and authorization by the Contracting Officer.

During any period of suspension, the Purchaser may withdraw performance and payment bond coverage aside from that deemed necessary by the Authorized Officer to secure cut and/or removed timber for which the Bureau of Land Management has not received payment, and/or unfulfilled contract requirements associated with harvest operations that have already occurred and associated post-harvest requirements.

In the event of a suspension period or a combination of suspension periods that exceed a total of thirty (30) days, the First Installment held on deposit may be temporarily reduced upon the written request of the Purchaser. For the period of suspension extending beyond thirty (30) days, the First Installment on deposit may be reduced to five (5) percent of the First Installment amount listed in Section 3.b. of the contract. Any First Installment amount temporarily reduced may be refunded or transferred to another BLM contract at the request of the Purchaser. However, if the Purchaser has outstanding debt owing the United States, the Contracting Officer must first apply the amount of First Installment that could be refunded to the debt owed in accordance with the Debt Collection Improvement Act, as amended (31 USC 3710, et seq.). Upon Purchaser's receipt of a bill for collection and written notice from the Contracting Officer lifting the suspension, the Purchaser shall restore the First Installment to the full amount shown in Section 3.b. of the contract within fifteen (15) days after the bill for collection is issued, subject to Section 3.j. of the contract. The Purchaser shall not resume contract operations until the First Installment amount is fully restored.

In the event of a suspension period or a combination of suspension periods that exceed a total of thirty (30) days, the unamortized Out-of-Pocket Expenses for road or other construction required pursuant to Exhibit C of the contract shall be refunded or transferred to another BLM contract at the request of the Purchaser. Upon written notice from the Contracting Officer lifting the suspension, the Purchaser shall reimburse the Government the amounts refunded or transferred. The Purchaser may choose to pay this reimbursement at once or in installments payable at the same time as payments are due for the timber under the contract and in amounts approximately equal to the expenses associated with the timber for which payment is due.

In the event that operating time is lost as a result of the incorporation of additional contract requirements, or delays due to Endangered Species Act consultation with the U.S. Fish and Wildlife Service or U.S. National Marine Fisheries Service, or court-ordered injunctions, the Purchaser agrees that an extension of time, without reappraisal, will constitute a full and complete remedy for any claim that delays due to the suspension hindered performance of the contract or resulted in damages of any kind to the Purchaser.

The Contracting Officer may determine that it is necessary to modify the contract or terminate the cutting and removal rights under the contract in order to comply with the Endangered Species Act, prevent incidental take of northern spotted owls in accordance with the ROD and RMP, (protect occupied marbled murrelet sites in accordance with the ROD and RMP), protect species that have been discovered which were identified for protection in accordance with management direction established in the ROD and RMP, or comply with a court order.

Following the issuance of a written notice that cutting and removal rights will be terminated, the Purchaser will be permitted to remove timber cut under the contract, if allowed by the Endangered Species Act, if able to proceed without causing incidental take of northern spotted owls in accordance with the ROD and RMP, consistent with marbled murrelet occupied site protection in accordance with the ROD and RMP, consistent with species protection in accordance with management direction established in the ROD and RMP, or court order requirements necessitating the modification or termination.

In the event the contract is modified or cutting and removal rights are terminated under this subsection, the Purchaser agrees that the liability of the United States shall be limited to the actual costs incurred by the Purchaser which have not been amortized by timber removed from the contract area. This calculation of liability shall utilize actual Purchaser costs and Government estimates of timber volumes. At the Authorized Officer's request, the Purchaser agrees to provide documentation of the actual costs incurred in the performance of the contract. In addition, the Purchaser shall be released from the obligation to pay the contract price for any timber which is not authorized to be removed from the contract area.

The Purchaser specifically and expressly waives any right to claim damages, other than those described in the preceding paragraphs, based on an alleged breach of any duty to the Purchaser, whether express or implied, in regard to the manner in which the Government defended the litigation which resulted in the court order affecting the operation of the contract. This waiver also extends to any claims based on effects on the operation of the contract that arise from litigation against another agency. Furthermore, the Purchaser specifically acknowledges and agrees that a court ruling that the Government violated the Administrative Procedures Act cannot be interpreted, in itself, to mean that the Government had not acted reasonably in regard to its duties to the Purchaser under this contract.

FIRE PREVENTION

aa. Primarily for purposes of fire prevention and control, the Purchaser shall, prior to the operation of power driven equipment in construction or logging operations under this contract during the fire season or periods of fire danger, prepare a fire prevention and control plan to the satisfaction of the Authorized Officer. Purchaser shall take such measures for prevention and suppression of fire on the contract area and other adjacent Government lands used or traversed by Purchaser in connection with operations as are required by applicable laws and regulations. However, when in the opinion of the Authorized Officer, weather and other conditions affecting fire incidence and control make special precautions necessary to protect the contract area and said Government lands, Purchaser shall take such additional or other fire prevention and control measures as may be required by the Authorized Officer.

The Purchaser shall comply with Oregon Department of Forestry Industrial Fire Precaution Level (IFPL) I Fire Season requirements. At IFPL II and III, additional fire prevention and control provisions may be added as determined by the Authorized Officer and specified in written instructions to the Purchaser to mitigate dry fuel and weather conditions.

LOGGING RESIDUE REDUCTION AND SITE PREPARATION

bb. In addition to the requirements of Sec. 15 of this contract, and notwithstanding the Purchasers' satisfactory compliance with State laws and regulations regarding offsetting or abating the additional fire hazard created by this operation and the States willingness to release the Purchaser from liability for such hazard, the Purchaser shall remain responsible to the Government for performance of the following hazard reduction measure(s) required by this contract: Perform logging residue reduction and site preparation work on approximately fifty-seven (57) acres of harvest area located within harvest units. The required work shall consist of any treatment or combination of treatments, as determined by the Authorized Officer and specified in writing by the Contracting Officer. The number of acres of each treatment shall be determined by the Authorized Officer. Prior to commencement of any operation under this Section of the contract, a slash disposal and pre-work conference between the purchaser's representative and the Authorized Officer must be held at a location designated by the Authorized Officer. The number of acres of each treatment shall be determined by the Authorized Officer. All slash disposal shall be done in accordance with the plans developed at this pre-work conference.

Slash, as defined for this section, shall mean all material (brush, limbs, tops, unmerchantable stems, and chunks) severed or knocked over as a result of purchasers operations under the terms of this contract.

1. Excavator pile and burn slash within portions of ground based regeneration harvest units as directed by the Authorized Officer and within twenty-five (25) feet of Roads 3-5-19.1, 3-5-20 (Von Road), 3-5-20.1, 3-5-29.3, and 3-5-29.4 in harvest areas shown on Exhibit A. Slash shall be piled by an excavator equipped with a hydraulic thumb and be no more than sixteen (16) feet in height or diameter. Finished piles shall be tight and free of dirt..
2. Unmerchantable logs greater than six (6) inches on the small end shall be left in place, or positioned so that they will not be burned.
 - a. Pacific madrone and Pacific dogwood shall be reserved and undamaged.
 - b. Machine piles shall be located as far as possible from green trees, snags, or unit boundaries to minimize damage.
 - c. Machine piles shall be kept free of dirt and other non-woody debris and constructed as compactly as possible. There should be an adequate supply of finer fuels located within and under the covered area of the pile to ensure ignition of the larger fuels.
 - d. A minimum 10-foot by 10-foot cover of four (4) mil. polyethylene shall cap each machine pile to maintain a dry ignition point. The cover shall be firmly fixed to each pile to hold it in place. Plastic shall be held in place with woody debris or tied with rope or twine. The plastic must be secured so that it is held in place during strong wind conditions. The Purchaser is required to furnish the covering materials. Covering shall be completed as directed by the Authorized Officer.

e. Cutting Areas shall be piled during the same season that they are logged.

3. Pile and burn landing slash within thirty (30) feet of the edge of each landing, all tops, broken pieces, limbs and debris between one (1) inch and eight (8) inches in diameter at the large end and between three (3) feet and eight (8) feet in length shall be piled within fifteen (15) days of completion of hauling logs from that landing. For larger material, refer to Sec. 42.h. Landing piles shall be kept free of dirt and located adjacent to roads at least twenty (20) feet from any reserve tree and/or as directed by the Authorized Officer. Upon completion of landing piling, the Purchaser shall prepare the landing piles for burning by securely covering each landing pile with four (4) mil. thick polyethylene plastic film at least twenty (20) feet wide. Landing piles shall be seventy-five (75) percent covered, with the covering extending three-quarters (3/4) of the way down all sides. The plastic shall be oriented southwest to northeast. Pieces of burnable material shall be placed on top of the plastic to secure it from moving and to prevent it from blowing off during strong wind episodes. The Purchaser is required to furnish the covering materials. The timing of this covering work shall be in accordance with instructions from the Authorized Officer. No landing debris shall be dozed off the landing and covered with dirt. Debris which has been buried and is determined to be the source of holdover fire shall be excavated by the Purchaser, at the Purchaser's expense, with a tractor and/or hydraulic excavator as directed by the Authorized Officer. If the structure of the landing piles will not permit adequate consumption of piled debris by burning, the Purchaser shall re-pile them at the direction of the Authorized Officer.

PRESCRIBED BURNING

cc. Notwithstanding the provisions of Sec. 15 of this contract, the Government shall assume all obligations for disposal or reduction of fire hazards created by Purchaser's operations on Government lands, except for burning and mop-up assistance as required herein. The Purchaser shall, under supervision of the Authorized Officer or designated representative, assist in preparing units for burning, burning, mop-up, and patrol by furnishing, at the Purchaser's own expense, the services of personnel and equipment on each unit as shown below:

1. For Igniting, Burning, and Mop-up of Piles on Units:

a. One (1) work leader(s) Firefighter Type 1 (FFT1) qualified according to National Wildfire Coordinating Group (NWCG) Wildland Fire Qualifications System guide, PMS 310-1) to supervise crew and equipment operations, and to serve as Purchaser's representative.

b. Ten-person crew Firefighter Type 2 (FFT2) qualified according to National Wildfire Coordination Group (NWCG) Wildland Fire Qualifications System guide, PMS 310-1, with sufficient fuel for burning, eleven (11) drip torches, one (1) power saw, and one (1) backpack pump, with one (1) tool for each crew member.

- c. The crew shall arrive on the project area with radios capable of inter-crew communications and communication with a BLM representative at a ratio of one (1) radio per every five (5) crew members.
- d. All ignition and mop-up personnel will be directly supervised by a BLM representative.

Aircraft and pilots used for Logging Residue Reduction or the suppression of escaped fires from Logging Residue Reduction operations, shall be acquired from a list of aircraft and pilots approved (i.e., carded for these specific activities) by the Office of Aircraft Services or the U.S. Forest Service. This list is available from BLM District Offices upon request.

All listed personnel shall be physically fit, experienced and fully capable of functioning as required. In addition, all listed personnel shall be qualified according to the National Wildfire Coordinating Group (NWCG) Wildland Fire Qualification System Guide, PMS-310-1 and provide documentation of these qualifications. On the day of ignition, all listed personnel shall be fluent in speaking and understanding English, clothing shall consist of long pants and long sleeved shirts, and be of approved aramid fabric (Nomex™ or equivalent), as well as being free of diesel fuel oil. All personnel shall wear lug sole boots with minimum eight (8) inch tall uppers that provide ankle support, approved hardhats, and leather gloves. Personnel who do not meet these requirements or do not have proper clothing and personal protective equipment (PPE) will not be allowed to participate. All listed tools and equipment shall be in good usable condition. All power-driven equipment shall be fully fueled and available for immediate use.

During periods of use under this subsection, the Purchaser shall provide fuel and maintenance for all such power-driven equipment.

Except as provided hereafter for fire escapement, the Purchaser shall continue the required assistance in mop up on each cutting unit shown on Exhibit A for seventy-two (72) hours, as directed by the Authorized Officer within a five (5) day period commencing at 8:00 a.m. the day following the completion of ignition in that unit, or until released from such service by the Government, whichever occurs first.

In event of a fire escapement, the Purchaser's personnel and equipment shall, under supervision of the Authorized Officer, take action to control and mop up the escaped fire until released from such service by the Government. If it becomes necessary to use furnished personnel and equipment for the suppression of a fire which escapes from the prescribed fire area for a period beyond the remainder of the day in which the fire escapes, then the Government shall, at its option: (1) reimburse the Purchaser for such additional use of personnel and equipment at wage rates shown in the current Administratively Determined Pay Rates for the Western Area and at equipment rates shown in the current Oregon-Washington Interagency Fire Fighting Equipment Rental Rates schedule until the Purchaser is released from such service by the Government; or (2) release the Purchaser from additional suppression work and assume responsibility for suppressing the escaped fire.

In situations where an escaped fire is controlled and contained by an adequate fire break (i.e., trail, road, stream, rock formation, etc.), the Government may permit the Purchaser to remove personnel for that day; provided that all mop up work on the escaped fire is included with mop up work on the prescribed fire area. In such an event, the Purchaser must sign a statement of agreement to complete mop up work on all escaped fire areas concurrently with mop up work on the prescribed fire area.

In case of injury to personnel or damage to equipment furnished as required by this subsection, liability shall be borne by the Purchaser, unless such injury or damage is caused by Government negligence.

Time is of the essence in complying with this provision. In the event the Purchaser fails to provide the personnel and equipment required herein, the Purchaser shall be responsible for all additional cost incurred by the Government in disposing of slash including but not limited to the wages and other costs of providing federal employees and others as substitute labor force, the cost of providing substitute equipment and appropriate additional overhead expenses. If the Purchaser's failure results in a deferral of burning and new conditions necessitate additional personnel and equipment to accomplish the planned burn, the Purchaser also shall be responsible for such additional costs.

CREATION OF COARSE WOODY DEBRIS

dd. In the Coarse Woody Debris Creation Units shown on Exhibit G, the Purchaser shall, upon completion of yarding, select and fell, saw-top, high-girdle, or basal-girdle nine hundred eighty-seven (987) standing live trees in accordance with Exhibit G.

No adjustments of volume or value shall be made to meet these requirements.

ee. The Purchaser shall create coarse woody debris in accordance with Section 42.dd. The Purchaser shall have the option of completing this work, or in lieu thereof, may make a contribution to the Bureau of Land Management in the amount of sixty-five thousand, six hundred ninety-two and 00/100 dollars (\$65,692.00), and upon making such contribution, the Purchaser shall be relieved of the obligations set out in this subsection. The Purchaser shall notify the Authorized Officer of their intention to make this contribution prior to the date of execution of this contract, and the Purchaser shall pay such amount in full prior to the commencement of operations.

LOG EXPORT RESTRICTION

ff. All timber sold to the Purchaser under the terms of the contract, except exempted species, is restricted from export under the United States in the form of unprocessed timber, and is prohibited from being used as a substitute for exported private timber. For the purpose of this contract, unprocessed timber is defined as (1) any logs except those of utility grade or below, such as saw logs, peeler logs, and pulp logs; (2) cants or squares to be subsequently remanufactured exceeding eight and three-quarters (8-3/4) inches in thickness; (3) split or round bolts or other round wood not processed to standards and specifications suitable for end-product uses; or (4) western redcedar lumber which does not meet lumber of American Lumber Standards Grades of Number 3 dimension or better, or Pacific Lumber Inspection Bureau R-List Grades of Number 3 Common or better. Thus, timber manufactured into the following will be considered processed: (1) lumber and construction timbers, regardless of size, manufactured to standards and specifications suitable for end product uses; (2) chips, pulp and pulp products; (3) green or dry veneer and plywood; (4) poles and piling cut or treated for use as such; (5) cants, squares, and lumber cut for remanufacturing of eight and three-quarters (8-3/4) inches in

thickness or less; (6) shakes and shingles. Substitution will be determined under the definition found in 43 CFR 5400.0-5(n).

The Purchaser is required to maintain and upon request to furnish the following information:

1. Date of last export sale.
2. Volume of timber contained in last export sale.
3. Volume of timber exported in the past twelve (12) months from the date of last export sale.
4. Volume of Federal timber purchased in the past twelve (12) months from date of last export sale.
5. Volume of timber exported in succeeding twelve (12) months from date of last export sale.
6. Volume of Federal timber purchased in succeeding twelve (12) months from date of last export sale.

In the event the Purchaser elects to sell any or all of the timber sold under this contract in the form of unprocessed timber, the Purchaser shall require each party buying, exchanging, or receiving such timber to execute a "Certificate as to Nonsubstitution and Domestic Processing of Timber". The original of such certification shall be filed with the Authorized Officer.

Additionally, when the other party is an affiliate of the Purchaser, the Purchaser will be required to update information under item (2) of Form 5450-17 (Export Determination) and file the form with the Authorized Officer.

In the event an affiliate of the Purchaser has exported private timber within twelve (12) months prior to purchasing or otherwise acquiring Federal timber sold under this contract, the Purchaser shall, upon request, obtain from the affiliate information in the form specified by the Authorized Officer and furnish the information to the Authorized Officer.

Prior to the termination of this contract, the Purchaser shall submit to the Authorized Officer Form 5460-15 (Log Scale and Disposition of Timber Removed Report) which shall be executed by the Purchaser. In addition, the Purchaser is required under the terms of this contract to retain for a three-year period from the date of termination of the contract the records of all sales or transfer of logs involving timber from the sale for inspection and use of the Bureau of Land Management.

Unless otherwise authorized in writing by the Authorized Officer, the Purchaser shall, prior to the removal of timber from the contract area, brand with Purchaser's registered log brand at least one end of each log, bolt, or other roundwood and identify each of these by painting with highway yellow paint.

In the event of the Purchaser's noncompliance with this subsection of the contract, the Authorized Officer may take appropriate action as set forth in Sec. 10. of this contract. In addition, the Purchaser may be declared ineligible to receive future awards of Government timber for a period of one (1) year.

Unless otherwise authorized in writing by the Contracting Officer, the Purchaser shall brand clearly and legibly one end of all logs with a scaling diameter (small end inside bark) of over ten (10) inches, prior to the removal of timber from the contract area.

All loads of eleven (11) logs or more will have a minimum of ten (10) logs clearly and legibly branded on one end regardless of the diameter of the logs. All logs will be branded on loads of ten (10) logs or less. One end of all branded logs to be processed domestically will be marked with a three (3) square inch spot of highway yellow paint. The Purchaser will stop trucks for accountability monitoring at mutually agreed upon locations when notified by the Authorized Officer.

If multiple trailers (mule trains) are used, each bunked load shall be considered an individual load, and these guidelines will apply to each bunked load. If a flatbed stake trailer is used, each bundle will be treated as a separate load.

At the discretion of the Contracting Officer, the Purchaser may be required to brand and paint all logs. Any increased costs for log branding and painting shall be the responsibility of the Purchaser.

TIMBER SALE CONTRACT MAP - CONTRACT NO. ORN04-TS-2019.0402

T03S-R05W Section 19 W. M. - NORTHWEST OREGON DISTRICT - OREGON

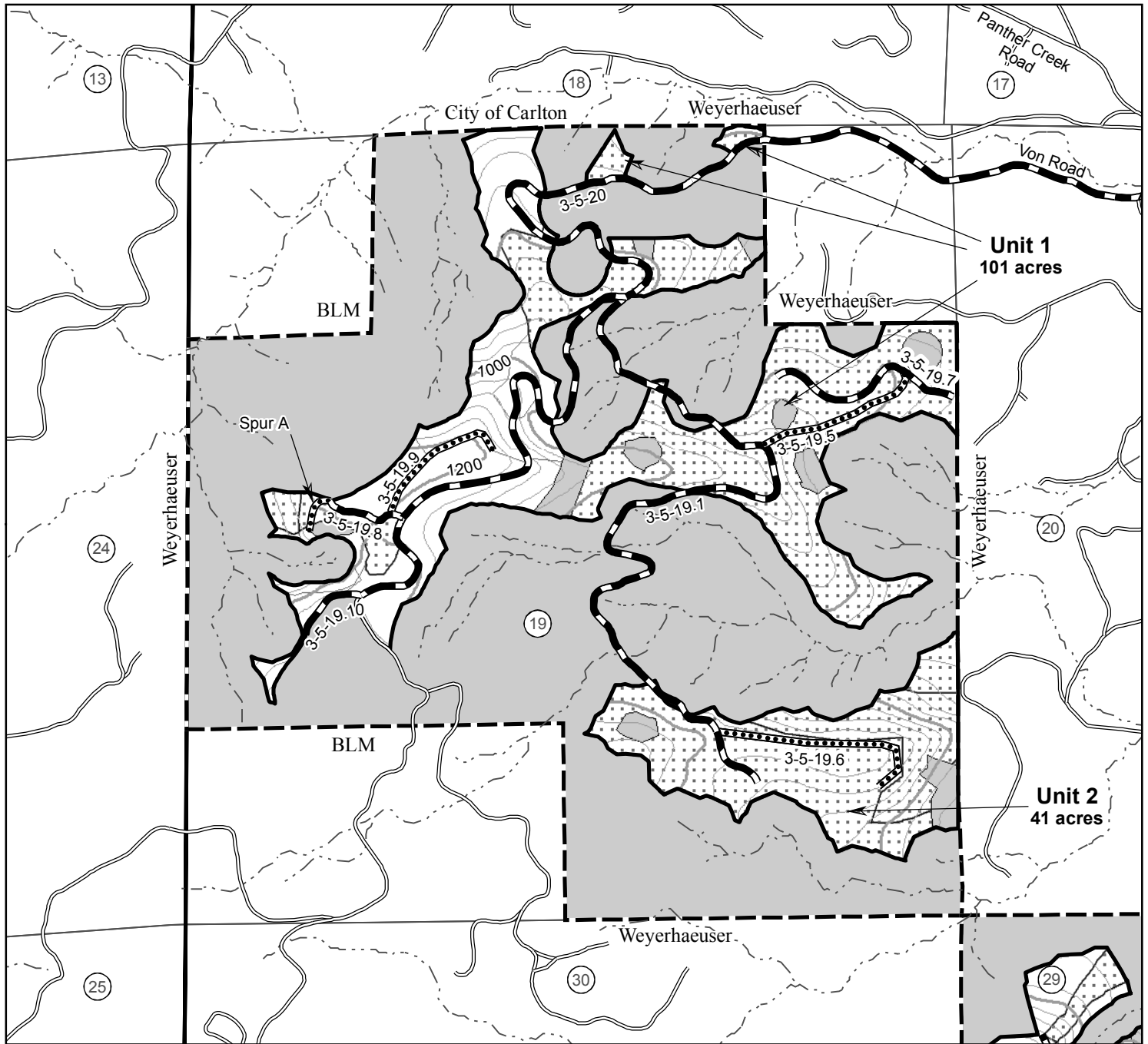

Contour Interval: 40ft

Partial Cut Area	166 Acres
Regeneration Cut Area	126 Acres
Right-of-Way Area	5 Acres
Reserve Area	508.2 Acres
Total Contract Area	805.2 Acres

- Partial Cut Area
- Regeneration Cut Area
- Boundary-Cutting Area
- Reserve Area
- Contract Area
- Road to be constructed
- Road to be improved
- Road to be renovated
- Other Roads
- Streams

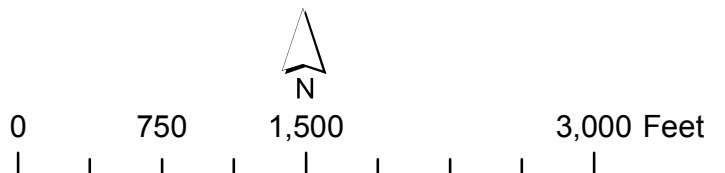

No warranty is made by the Bureau of Land Management as to the accuracy, reliability, or completeness of these data for individual or aggregate use with other data. Original data were compiled from various sources and may be updated without notification. Note: Boundaries of harvest area are painted orange and posted, and right-of-ways (ROW) are posted. Harvest area acres do not include existing roads. Acres shown on Exhibit A for harvest area have been computed using a S1 mobile mapper and Trimble R1 GNSS Receiver. Prepared By: cswen Date: 7/16/2019

TIMBER SALE CONTRACT MAP - CONTRACT NO. ORN04-TS-2019.0402

T03S-R05W Section 29 W. M. - NORTHWEST OREGON DISTRICT - OREGON

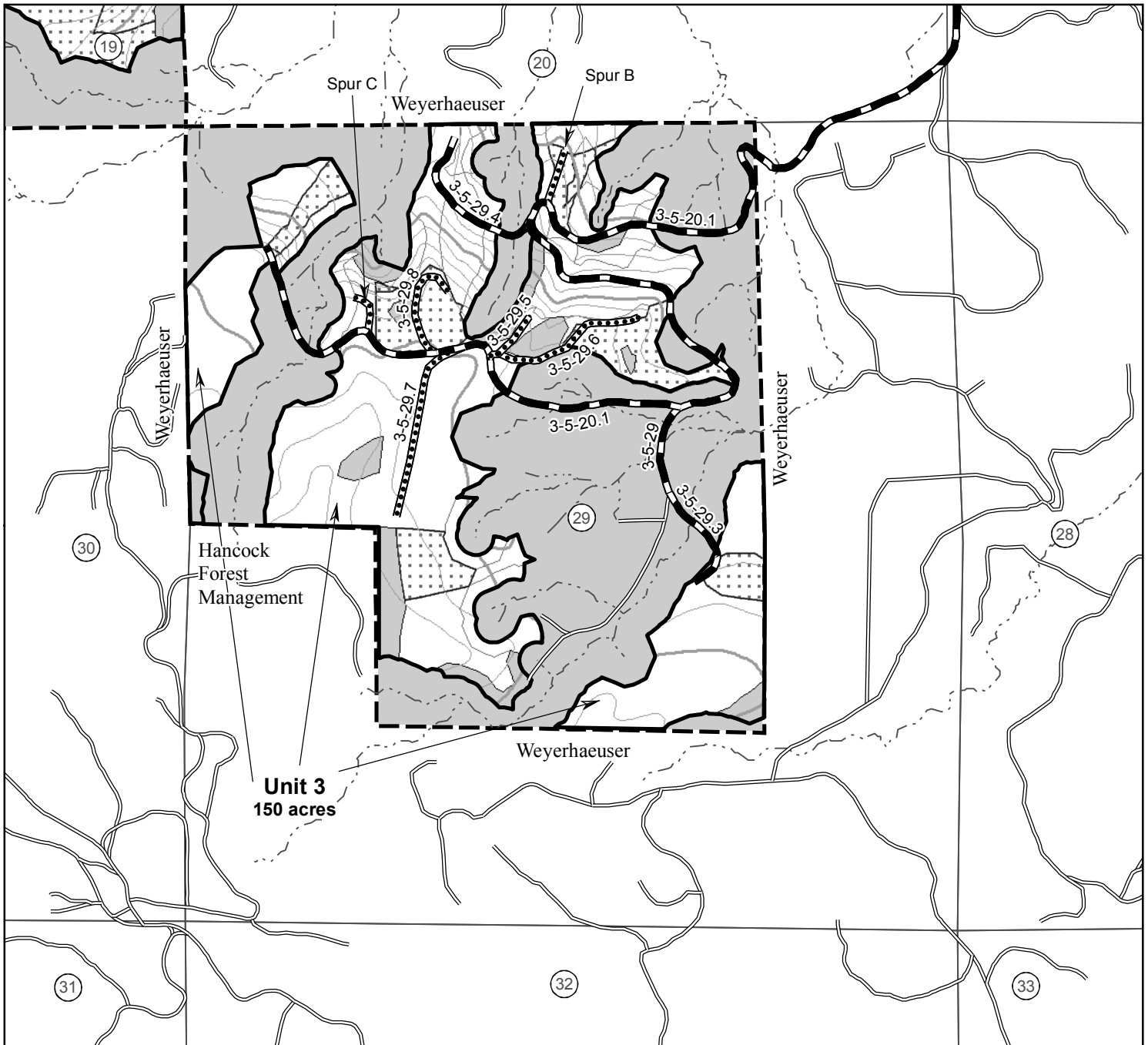

Contour Interval: 40ft

- Partial Cut Area
- Regeneration Cut Area
- Boundary-Cutting Area
- Reserve Area
- Contract Area
- Road to be constructed
- Road to be renovated
- Other Roads
- Streams

Partial Cut Area	166 Acres
Regeneration Cut Area	126 Acres
Right-of-Way Area	5 Acres
Reserve Area	508.2 Acres
Total Contract Area	805.2 Acres

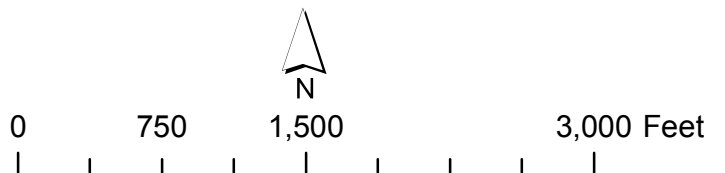

No warranty is made by the Bureau of Land Management as to the accuracy, reliability, or completeness of these data for individual or aggregate use with other data. Original data were compiled from various sources and may be updated without notification. Note: Boundaries of harvest area are painted orange and posted, and right-of-ways (ROW) are posted. Harvest area acres do not include existing roads. Acres shown on Exhibit A for harvest area have been computed using a S1 mobile mapper and Trimble R1 GNSS Receiver. Prepared By: csween Date: 7/16/2019

UNITED STATES DEPARTMENT OF THE INTERIOR
 BUREAU OF LAND MANAGEMENT (BLM)

EXHIBIT B / PRE-SALE

SCALE SALE PURCHASE PRICE SCHEDULE AND MEASUREMENT SPECIFICATIONS

I. Total Actual Purchase Price – In accordance with Sections 2 and 3 of the contract, the Purchaser agrees to pay the Government for the forest products sold under the contract in accordance with the following schedule and measurement requirements. Forest products sold are comprised of *Merchantable Timber, Other Timber, Other Forest Products, Remaining Volume, and Defect Caused by Abnormal Delay* as defined in this Exhibit. In the event an Extension of Time is approved, the prices per measurement unit are subject to readjustment (refer to Section 9 of the contract).

Schedule of Products, Species, Measurement Units, and Prices		
Species	Measurement Units	Price Per Measurement Unit
Merchantable Timber:		
Douglas-fir	MBF	\$221.30
western redcedar	MBF	\$403.20
bigleaf maple	MBF	\$39.30
grandfir	MBF	\$105.30
western hemlock	MBF	\$84.70
red alder	MBF	\$348.00
Other Wood Products:		
marginal logs	Green Tons	\$5.00

II. Merchantable Timber – All timber which can be cut into logs, which equal or exceed the following specifications, shall be considered merchantable timber. Purchaser shall pay for same in accordance with Section 3 of the contract at the prices per measurement unit shown in Section I of this Exhibit.

Schedule of Minimum Merchantable Log Specifications			
Species and Products	Length	Diameter (inside bark at small end)	Net Scale
All	16 Feet	6 inches	20 bf

III. Other Timber – If Purchaser elects to remove any logs which do not meet the above minimum merchantable log specifications in Section II of this Exhibit, are not designated as other forest products in Section I of this Exhibit, and have not been reserved to the Government in Section 41 of the contract, such logs shall be scaled for their merchantable content as provided herein and be paid for in accordance with Sections 2 and 3 of the contract and the prices per measurement unit in Section I of this Exhibit. If any timber is of a species or size not listed in Section II of this Exhibit (above) or is of a quality different from merchantable timber described herein, the Authorized Officer shall establish volumes and values in accord with BLM prescribed procedures.

IV. Deterioration Caused by Abnormal Delay – Scaling deductions made for rot, checks, or other deterioration resulting from abnormal delay in scaling caused by Purchaser shall be recorded separately and charged to the Purchaser in accordance with Section 3.(e). of the contract.

V. Remaining Volume – *Remaining volume* is defined in Section 3.(e). of the contract. The remaining volume of any forest products sold under the contract, and any deterioration due to abnormal delay shall be determined as provided in Section 3.(e). of the contract. Purchaser shall pay for same in accordance with Section 3 of the contract at the prices per measurement unit shown in Section I of this Exhibit. To maximize utilization, the Purchaser shall buck logs to variable merchantable lengths. If the Purchaser fails to buck logs to variable merchantable lengths, the Contracting Officer may measure unyarded log segments and bill the Purchaser for their value.

The Contracting Officer may determine during operations that the amount of remaining volume found is excessive and/or preventing the attainment of BLM treatment objectives. Upon such determination as directed in writing by the Contracting Officer, the Purchaser shall restring cable yarding lines, re-traverse ground-based yarding areas, and/or re-fly aerial yarding areas; and yard, remove, and present for scaling the material which would otherwise be designated as remaining volume.

VI. Scaling

A. Scaling Service – Log scaling services shall be provided and performed by Government scalers or parties under contract to BLM, as determined by the Contracting Officer. Purchaser shall notify the Authorized Officer three (3) days prior to commencing any hauling, including any hauling shutdowns longer than two (2) days, and at the earliest opportunity when ceasing hauling operations performed under the contract.

A Scaling Authorization must be completed and approved by the Authorized Officer prior to beginning operations. A Yard Scaling Agreement must be completed for each utilization facility that will receive logs from the sale, which must be scaled, and executed by the Purchaser, Scale Site Owner, and Contracting Officer prior to the delivery of any logs to that facility. Government scalers or contract scalers are authorized to collect scale data from all loads.

B. Log Rule and Measurement

All logs shall be scaled according to the Eastside Scribner Log Rules found in the Northwest Log Rules Eastside and Westside Log Scaling Handbook in the Official Rules for Log Scaling and Grading Bureaus developed by the Northwest Log Rules Advisory Group dated July 1, 2003 (reprinted June 1, 2006). The Contracting Officer may elect to utilize sample scaling in lieu of 100 percent scaling of log loads. The sample log scaling procedures, including sample design and number of log sorts, will be determined by the Authorized Officer in accordance with BLM prescribed procedures.

C. Log Presentation – Purchaser shall present logs so that they may be scaled in an economical and safe manner in accordance with the Yard Scaling Agreement(s) required in Section VI.A. of this Exhibit.

D. Check Scale – Government scalers will conduct check scales as set forth below:

1. Check scale shall include at least 200 logs or at least 50 MBF.
2. Utilize a sample that will accurately represent the species and defect associated with the sale.
3. For complex scaling situations, conduct the appropriate analysis to determine sample size. Increase the number of logs check scaled if sample size analysis deems it necessary.
4. Use the following standards to determine the proficiency of individual Government scalers or scalers under contract to BLM:

- a. Gross Scale. A variance of one point five percent (1.5%) in gross scale is the standard unless otherwise justified.
- b. Net scale. The allowable variance is as follows:

Check Scaler's Percent Defect in Logs	Scalers Allowable Variance
0-10 percent	2 percent
over 10 percent	.2 x percent defect to a maximum of 5 percent

5. Determinations as to volume of timber made by a Government check scaler in conformance with the standards as set forth herein shall be final. All loads check scaled by Government scalers will be identified with the check scaler's initials legibly marked or painted in the face of the first log in each load. When such checks show a variance in scale in excess of acceptable standards, in two or more consecutive check scales, an adjustment to the volume reported as scaled will be made by BLM. Such adjustments will be made based on the difference between available Government check scales and the original scale during the period covered by the unsatisfactory check scales. Unless otherwise approved in writing by the Contracting Officer, the volume to which this difference will be applied will be 50 percent of the volume scaled between the last satisfactory check and the first unsatisfactory check, 100 percent of the volume scaled during the unsatisfactory check, and 50 percent of the volume between the last unsatisfactory check scale and the next satisfactory check scale.

E. Accountability

1. All logs will be painted and branded at the landing and accounted for in accordance with Section 42.gg of the contract. Each truck driver shall obtain a load receipt and a BLM scaler receipt from the Log Truck Ticket Book issued by the Authorized Officer and comply with the instructions specified on the cover of said book. All log/load tickets will be marked with the Exhibit A unit number using a permanent marker or indelible stamp as directed by the Authorized Officer. While products are in transit, the truck driver shall display the load receipt and BLM scaler receipt on the bunk or wing log at the front of the load on the driver's side, or as directed by the Authorized Officer in the case of other forest products.

All forest products on each load shall be delivered to the destination listed on the load receipt. The BLM scaler receipt shall be surrendered at the location of BLM scaling, the unloading location, or as requested by BLM.

2. The Purchaser shall not haul forest products from the contract area on weekends, Memorial Day, Fourth of July, Labor Day, Thanksgiving, Christmas, and New Year's holidays; or outside the hours of 4:00 am to 8:00 pm daily, unless otherwise approved in writing by the Authorized Officer or designated in the Approved Logging Plan.

3. The Purchaser shall furnish BLM a map showing the route which shall be used to haul forest products from the forest product sale area to the scaling location(s). Such route shall be the most direct haul route between the two points, unless another route is approved by BLM. The route of haul may be changed only with advance notice to the Authorized Officer and approval by BLM. The haul route map shall be attached to the Scaling Authorization.

4. All log loads will be scaled at scale locations listed on the Scaling Authorization as approved by the Authorized Officer. The Purchaser shall ensure that all scale site owners listed on the Scaling Authorization enter into a Yard Scaling Agreement before requesting BLM approval of the Scaling Authorization. Areas for scaling BLM logs will be designated on the ground and identified on the yard map as required in the Yard Scaling Agreement.

5. Any removal of logs from loaded trucks prior to their arrival at the delivery point as required by the contract shall be considered a willful trespass and render the Purchaser liable for damages under applicable law. Any payment made for purchase of such logs shall be deducted from the amount due because of trespass.

F. **Scaling Lost Forest Products** – The value of forest product loads represented by missing load tickets shall be equal to the highest value load for the month in which the lost load is hauled regardless of where the highest value load is scaled. If no loads have been scaled in that month, value will be determined from the closest month in which loads were scaled.

(VII.) Estimated Volumes and Values – The following volume estimates and calculations of value of forest products sold are made solely as an administrative aid for determining payment amounts, when payments are due, the value of forest products subject to any special bonding provisions, and other purposes specified in various portions of the contract. The cutting areas are shown on Exhibit A of the contract.

A. **Forest Product Volume Removed from Contract Area** – The total volume of removed forest products shall be determined using the Government's records of scaled volumes of forest products skidded or yarded monthly, or a shorter period if agreed to by the Purchaser and Government, to loading points or removed from the contract area.

B. **Forest Products Not Yet Removed from Contract Area** – The value of forest products which have not been removed will be determined by multiplying the value per acre as shown below times the amount of acreage subject to the purpose of the value determination, as determined by the Authorized Officer. The estimated volume and value per acre used for determining payment amounts may be modified by the Authorized Officer based upon scale report data on forest product volume removed from the contract area.

Total Estimated Purchase Price and/or Schedule of Volumes and Values for Forest Products Not Yet Removed from Contract Area					
Cutting Area		Total Estimated Volume (MBF)		Total Estimated Purchase Price	
Cutting Area Number	Exhibit A Acres	Volume per Acre	Total Volume	Value per Acre	Total Value
Unit 1	101	33.3	3,364	\$7,568.61	\$764,429.70
Unit 2	41	42.8	1,755	\$9,736.17	\$399,183.00
Unit 3	150	21.9	3,292	\$4,976.31	\$746,446.30
Right-of-way	5	45.6	228	\$10,216.44	\$51,082.20
Marginal Logs	0	N/A	500 Green Tons	N/A	\$675.00
Sale Total	297		4,185 MBF		\$1,365,176.70

150: ROAD PLAN AND DETAIL SHEET

Road Number	Start Station or Milepost	End Station or Milepost	Total Length	Typical Cross Section	Min. Curve Radius	ROAD WIDTH		GRADIANT		SURFACING (*5)								Remarks		
						Subgrade	Ditch	Max. Favorable	Max. Adverse	BASE COURSE				SURFACE COURSE						
										Min. Width	Comp. Depth	Surface Type (*3)	Grading Size (*3)	Number of Lifts	Min. Width	Comp. Depth	Surface Type (*3)		Grading Size (*3)	Number of Lifts
3-5-19.1	0+00	53+29	53+29	6		14'	2'			13'	4"	ABC	A	1	12'	4"	ASC	C	1	Renovation. Construct turnouts, turnarounds, waste areas, and landings as marked. Spread a 4" lift of 3'-0" Crushed Base Rock (approx. 1,217 CY) capped with a 4" lift of 1 1/2"-0" Crushed Rock (approx. 1,217 CY). Spread 370 CY of 3"-0" Crushed Spot/Base Rock as marked and needed. Spread 150 CY of 1 1/2"-0" Crushed Spot/Cap Rock as marked and needed. Place 285 CY of 1 1/2"-0" Crushed Culvert Bedding/Backfill Rock as marked. Place 165 CY of Class 3 Rip-Rap as fill armor and energy dissipater as marked. Install 6 sediment catch basins with straw bales as marked. Construct ditchouts as marked. Remove existing waterbars as directed. Install a French drain with non-woven geotextile fabric (1,250 ft ²), drain rock (50 CY), and a corrugated metal perforated pipe @ Sta. 39+13 as directed. Widen existing road prism 2' to the right @ Sta. 5+76. Heavy ditchline re-establishment @ Sta. 27+06. Widen existing road prism 3' to the right @ Sta. 51+23-51+73. Haul excess material to WA as directed. Install 2 culverts and replace 10 culverts. Install 11 inlet markers.
3-5-19.5	0+00	11+87	11+87	5		14'	2'	15%	15%			ABC	A				ASC	C		New Construct. Construct turnouts and turnarounds as marked. Spread 60 CY of 3'-0" Crushed Spot/Base Rock as marked and needed. Spread 40 CY of 1 1/2"-0" Crushed Spot/Cap Rock as marked. Place 55 CY of 1 1/2"-0" Crushed Culvert Bedding/Backfill Rock as marked. Construct ditchouts as marked. Cut and drift material @ Sta. 0+18 - 1+79. Haul excess material to designated WA as directed. Install 3 culverts. Install 2 inlet markers.
3-5-19.5A	10+57	12+21	1+64	5		14'	2'	15%	15%			ABC	A				ASC	C		New Construct. Beginning of Y junction with 3-5-19.5. Spread 20 CY of 3'-0" Crushed Spot/Base Rock as marked. Spread 20 CY of 1 1/2"-0" Crushed Spot/Cap Rock as marked and needed. Place 20 CY of 1 1/2"-0" Crushed Culvert Bedding/Backfill Rock as marked. Install 1 culvert.
3-5-19.6	0+00	14+57	14+57	6		14'	2'	10%	10%	13'	4"	ABC	A	1	12'	4"	ASC	C	1	New Construct. Construct turnouts, turnarounds, and landings as marked. Spread a 4" lift of 3'-0" Crushed Base Rock (approx. 327 CY) capped with a 4" lift of 1 1/2"-0" Crushed Rock (approx. 327 CY). Spread 70 CY of 3'-0" of Crushed Spot/Base Rock as marked. Spread 50 CY of 1 1/2"-0" Crushed Spot/Cap Rock as marked. Place 50 CY of 1 1/2"-0" Crushed Culvert Bedding/Backfill Rock as marked. Cut and drift material to fix road grade as marked. Haul excess material to designated WA as directed. Install 2 culverts. Install 1 inlet marker.
3-5-19.7	0+00	15+65	15+65	6		14'	2'					ABC	A				ASC	C		Renovation. Construct turnouts, turnarounds, waste areas, and landings as marked. Spread 60 CY of 3'-0" Crushed Spot/Base Rock as marked and needed. Spread 40 CY of 1 1/2"-0" Crushed Spot/Cap Rock as marked and needed. Place 35 CY of 1 1/2"-0" Crushed Culvert Bedding/Backfill Rock as marked. Construct ditchouts as marked. Excavate failing fill slope material @ Sta. 8+18 and 10+17 and haul to designated WA as directed. Widen existing road prism into cut bank by 4' to the right from Sta. 8+18-9+18. Widen existing subgrade to the left by 3' @ Sta. 11+23. Install 2 culverts. Install 2 inlet markers.
3-5-19.8	0+00	1+27	1+27	6		14'	2'			13'	4"	ABC	A	1	12'	4"	ASC	C	1	Renovation. Re-establish ditchline and haul material to WA as directed. Spread a 4" lift of 3'-0" Crushed Base Rock (approx. 29 CY) capped with a 4" lift of 1 1/2"-0" Crushed Rock (approx. 29 CY). Spread 40 CY of 3'-0" Crushed Spot/Base Rock as marked and as needed. Spread 10 CY of 1-1/2"-0" Crushed Spot/Cap Rock as needed. Place 35 CY of 1 1/2"-0" Crushed Culvert Bedding/Backfill Rock as marked. Install 1 culvert.
	1+27	1+70	0+43	5		14'	2'													Renovation. Re-establish ditchline and haul material to WA as directed.
	1+70	4+19	2+49	5		14'	2'													Improvement. Construct turnarounds and waste areas as marked. Excavate rolling grade from subgrade @ Sta. 2+00 to level subgrade. Cut and drift material ahead to allow for proper drainage @ Sta. 4+19. Haul excess material to designated WA as directed.
	4+19	5+41	1+22	5		14'	2'					ABC	A				ASC	C		Renovation. Re-establish ditchline and haul material to WA as directed. Spread 10 CY of 3'-0" Crushed Spot/Base Rock as marked. Spread 10 CY of 1 1/2"-0" Crushed Spot/Cap Rock as marked. Place 10 CY of 1 1/2"-0" Crushed Culvert Bedding/Backfill Rock as marked. Install 1 culvert. Install 1 inlet marker.

*NOTES

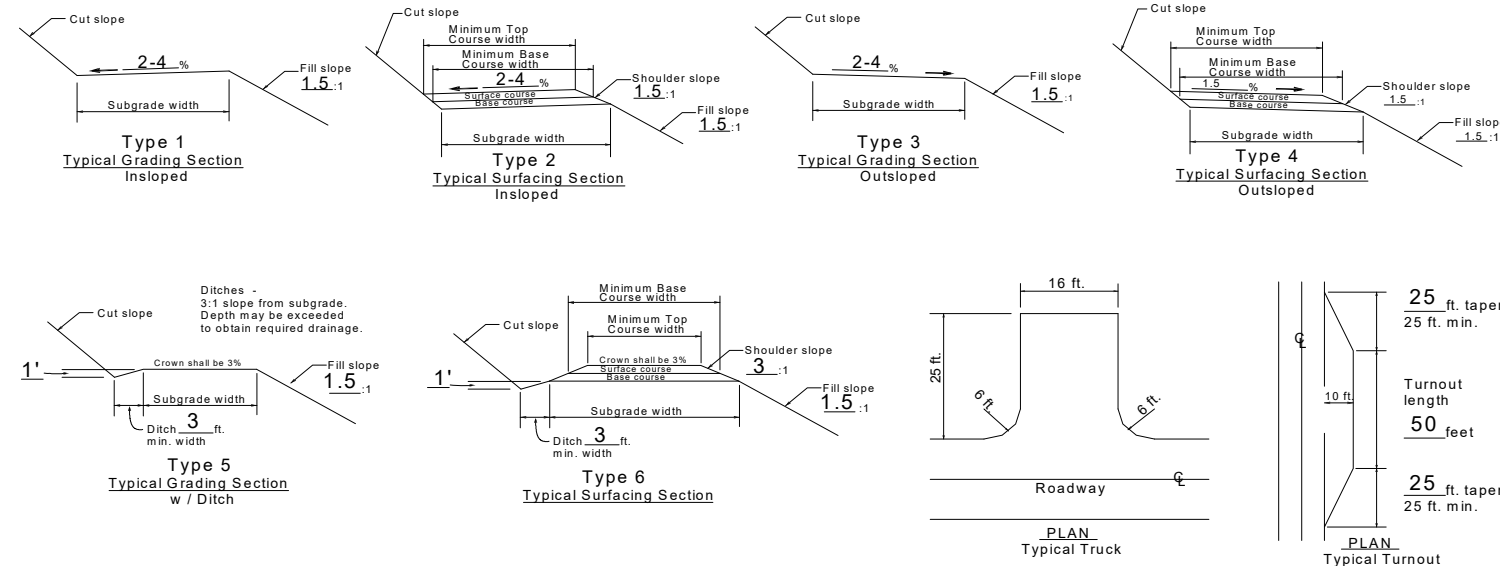

- Extra subgrade widths**
Add to each shoulder: 1 ft. for fills of 1-6 ft. and 2 ft. for fills over 6 ft. Widen the inside shoulder of curves as follows:
(See Road Plan Map, Exhibit C)
- Backslopes**
Materials Cut slopes Fill slopes
Solid rock 1/4:1 Angle of repose
Soft rock and shale 1/2:1
Common
Slopes under 55% 1:1 1-1/2:1
Slopes over 55% 3/4:1 1-1/2:1
- Surface type**
PRR - Pit run rock Grading A - 3"
GRR - Grid rolled rock B - 2" (base course)
SRN - Screened rock C - 3" jaw run
JRR - Jaw run rock
ABC - Aggr. base course C - 1-1/2"
ASC - Aggr. surface course D - 1" (surface course)
WC - Wood chips E - 3/4"
- Turnouts**
Width - 10 ft. in addition to subgrade width, or as shown on the plans.
Located approximately as shown on the plans.
Intervisible and not more than 750 ft. apart.
- Surfacing**
Turnouts, curve widening and road approach aprons shall be surfaced.
- Clearing width** 200
See Section
- As posted and painted for Right-of-Way:
- Drainage**
See Culvert List
- Compaction** 300 and 400
See Sections

* Clearing Limits as posted on ground

150: ROAD PLAN AND DETAIL SHEET

Road Number	Start Station or Milepost	End Station or Milepost	Total Length	Typical Cross Section	Min. Curve Radius	ROAD WIDTH		GRADIENT		SURFACING (*5)										Remarks
						Subgrade	Ditch	Max. Favorable	Max. Adverse	BASE COURSE					SURFACE COURSE					
										Min. Width	Comp. Depth	Surface Type (*3)	Grading Size (*3)	Number of Lifts	Min. Width	Comp. Depth	Surface Type (*3)	Grading Size (*3)	Number of Lifts	
3-5-19.9	0+00	10+91	10+91	6		14'	2'	15%	15%	13'	4"	ABC	A	1	12'	4"	ASC	C	1	New Construct. Construct turnout, turnaround, and landing (approx. 30' radius) as marked. Spread a 4" lift of 3"-0" Crushed Base Rock (approx. 245 CY) capped with a 4" lift of 1 1/2"-0" Crushed Rock (approx. 245 CY). Spread 130 CY of 3"-0" Crushed Spot/Base Rock as marked. Spread 60 CY of 1 1/2"-0" Crushed Spot/Cap Rock as marked. Place 85 CY of 1 1/2"-0" Crushed Culvert Bedding/Backfill Rock as marked. Widen road to the left by 8' from Sta. 8+67 - 9+97. Install 4 culverts. Install 1 inlet marker.
3-5-19.10	0+00	4+37	4+37	3		14'	0'					ABC	A				ASC	C		Renovation. Construct turnaround and landing (approx. 30' radius) as marked. Spread 50 CY of 3"-0" Crushed Spot/Base Rock as marked and needed. Spread 30 CY of 1 1/2"-0" Crushed Spot/Cap Rock as marked and needed. Place 25 CY of 1 1/2"-0" Crushed Culvert Bedding/Backfill Rock as marked. Remove mound of soil and backfill trench with same material @ Sta. 0+45. Excavate into cut bank to achieve desired subgrade width @ Sta. 0+98. Widen existing road prism 3' to the right from Sta. 2+10 - 2+60. Install 1 culvert.
3-5-20.1	0+00	11+92	11+92	6		14'	2'					ABC	A				ASC	C		Renovation. Re-establish ditchline and haul material to designated WA as directed. Spread 60 CY of 3"-0" Crushed Spot/Base Rock as marked and needed. Spread 35 CY of 1 1/2"-0" Crushed Spot/Cap Rock as marked and needed. Construct 1 sediment catch basin with straw bale @ Sta. 3+20. Remove root mass on shoulder of road @ Sta. 9+80. Construct a ditchout left @ Sta. 10+45. Install 1 inlet marker.
	11+92	13+26	1+34	6		14'	2'					ABC	A				ASC	C		Improvement. Road is widening/shifting to the left, refer to design notes. Excavate into cut bank to achieve desired subgrade width and haul excess material to designated WA as directed. Spread 25 CY of 3"-0" Crushed Spot/Base Rock as marked and needed. Spread 15 CY of 1 1/2"-0" Crushed Spot/Cap Rock as marked or needed. Place 50 CY of Class 5 Rip-Rap at inlet for stabilization wall and fill material @ Sta. 12+21. Construct a sediment catch basin with straw bale @ Sta. 12+73.
	13+26	50+14	36+88	6		14'	2'					ABC	A				ASC	C		Renovation. Construct turnouts, turnarounds, and waste areas as marked. Re-establish ditchline and haul material to designated WA as directed. Spread 265 CY of 3"-0" Crushed Spot/Base Rock as marked and needed. Spread 160 CY of 1 1/2"-0" Crushed Spot/Cap Rock as marked and needed. Place 55 CY of 1 1/2"-0" Crushed Culvert Bedding/Backfill Rock as marked. Place 5 CY of Class 3 Rip-Rap @ Sta. 24+17 at inlet and backfill with suitable material to achieve desired subgrade width. Place 140 CY of Class 5 Rip-Rap from Sta. 39+59 - 40+20 and construct a stabilization wall on the fill slope. Construct ditchouts as marked. Widen curve to the right by 5' @ Sta. 14+84. Construct 2 sediment catch basins with straw bales as marked. Remove stumps and logs on existing road and fix road alignment @ Sta. 31+57. Install a French drain with non-woven geotextile fabric (5,500 ft ²), drain rock (230 CY), and a corrugated metal perforated pipe from Sta. 39+59 - 40+20. Haul excess material to Spur B landing to fix grade or haul to designated WA as directed. Excavate slide material on existing road and haul to designated WA as directed from Sta. 40+48 - 41+00. Install 2 culverts and replace 1 culvert with a 10' downspout. Install 7 inlet markers.
	50+14	52+23	2+09	6		14'	2'			13'	4"	ABC	A	1	12'	4"	ASC	C	1	Improvement. Road is widening/shifting to the right into cut bank. Spread a 4" lift of 3"-0" Crushed Base Rock (approx. 47 CY) capped with a 4" lift of 1 1/2"-0" Crushed Rock (approx. 47 CY). Spread 5 CY of 3"-0" Crushed Spot/Base Rock as needed. Spread 5 CY of 1 1/2"-0" Crushed Spot/Cap Rock as needed. Place 35 CY of 1 1/2"-0" Crushed Culvert Bedding/Backfill Rock as marked. Excavate failing fill slope material from Sta. 50+71 - 51+43 and haul waste material to designated WA as directed and back fill with suitable local fill material. Replace 1 culvert. Install 1 inlet marker.

Type 1
Typical Grading Section
Insloped

Type 2
Typical Surfacing Section
Insloped

Type 3
Typical Grading Section
Outsloped

Type 4
Typical Surfacing Section
Outsloped

Type 5
Typical Grading Section
w/ Ditch

Type 6
Typical Surfacing Section

PLAN
Typical Truck

PLAN
Typical Turnout

***NOTES**

- Extra subgrade widths**
Add to each shoulder: 1 ft. for fills of 1-6 ft. and 2 ft. for fills over 6 ft. Widen the inside shoulder of curves as follows:
(See Road Plan Map, Exhibit C)
- Backslopes**
Materials Cut slopes Fill slopes
Solid rock 1/4:1 Angle of repose
Soft rock and shale 1/2:1
- Common**
Slopes under 55% 1:1 1-1/2:1
Slopes over 55% 3/4:1 1-1/2:1
- Turnouts**
Width - 10 ft. in addition to subgrade width, or as shown on the plans.
Located approximately as shown on the plans. Intervisible and not more than 750 ft. apart.
- Surfacing**
Turnouts, curve widening and road approach aprons shall be surfaced.
- Clearing width**
See Section 200.
- As posted and painted for Right-of-Way:
- Drainage**
See Culvert List
- Compaction**
See Sections 300 and 400

Note:
Full bench construction is required on side slopes exceeding 60%.

3. Surface type	Grading
PRR - Pll run rock	A - 3"
GRR - Grid rolled rock	B - 2"
SRN - Screened rock	C - 3" jaw run (base course)
JRR - Jaw run rock	
ABC - Aggr. base course	C - 1-1/2"
ASC - Aggr. surface course	D - 1"
WC - Wood chips	E - 3/4" (surface course)

* Clearing Limits as posted on ground

150: ROAD PLAN AND DETAIL SHEET

Road Number	Start Station or Milepost	End Station or Milepost	Total Length	Typical Cross Section	Min. Curve Radius	ROAD WIDTH		GRADIENT		SURFACING (*5)										Remarks	
						Subgrade	Ditch	Max. Favorable	Max. Adverse	BASE COURSE					SURFACE COURSE						
										Min. Width	Comp. Depth	Surface Type (*3)	Grading Size (*3)	Number of Lifts	Min. Width	Comp. Depth	Surface Type (*3)	Grading Size (*3)	Number of Lifts		
3-5-20.1 (Cont.)	52+23	64+79	12+56	6		14'	2'														Renovation. Construct waste areas and ditchouts as marked. Re-establish ditchline and haul material to designated WA as directed. Spread 110 CY of 3"-0" Crushed Spot/Base Rock as marked and needed. Spread 70 CY of 1 1/2"-0" Crushed Spot/Cap Rock as marked and needed. Place 40 CY of 1 1/2"-0" Crushed Culvert Bedding/Backfill Rock as marked. Install 2 culverts. Install 3 inlet markers.
	64+79	66+10	1+31	6		14'	2'			13'	4"	ABC	A	1	12'	4"	ASC	C	1	Renovation. Re-establish ditchline and haul material to designated WA as directed. Spread a 4" lift of 3"-0" Crushed Base Rock (approx. 30 CY) capped with a 4" lift of 1 1/2"-0" Crushed Rock (approx. 30 CY). Spread 5 CY of 3"-0" Crushed Spot/Base Rock as needed. Install 1 inlet marker.	
	66+10	68+91	2+81	4		14'	0'			13'	4"	ABC	A	1	12'	4"	ASC	C	1	Renovation. Stream in left side ditch, upslope subgrade away. Spread a 4" lift of 3"-0" Crushed Base Rock (approx. 64 CY) capped with a 4" lift of 1 1/2"-0" Crushed Rock (approx. 64 CY). Spread 5 CY of 3"-0" Crushed Spot/Base Rock as needed. Spread 5 CY of 1 1/2"-0" Crushed Spot/Cap Rock as needed.	
	68+91	69+23	0+32	6		14'	2'			13'	4"	ABC	A	1	12'	4"	ASC	C	1	Renovation. Re-establish ditchline and haul material to designated WA as directed. Spread a 4" lift of 3"-0" Crushed Base Rock (approx. 7 CY) capped with a 4" lift of 1 1/2"-0" Crushed Rock (approx. 7 CY).	
	69+23	88+20	18+97	6		14'	2'						ABC	A				ASC	C		Renovation. Construct turnouts, ditchouts, and waste areas as marked. Re-establish ditchline and haul material to designated WA as directed. Spread 150 CY of 3"-0" Crushed Spot/Base Rock as marked and needed. Spread 105 CY of 1 1/2"-0" Crushed Spot/Cap Rock as marked and needed. Place 100 CY of 1 1/2"-0" Crushed Culvert Bedding/Backfill Rock as marked. Enter through cut @ Sta. 80+18, excavate cut bank material that has slid onto existing road and construct a ditchline on both sides of the road. Haul excess material to designated WA as directed. Install 4 culverts and replace 1 culvert. Install 5 inlet markers.
	88+20	89+85	1+65	4		14'	0'			13'	4"	ABC	A	1	12'	4"	ASC	C	1	Renovation. Wet land to the left, upslope subgrade away. Spread a 4" lift of 3"-0" Crushed Base Rock (approx. 37 CY) capped with a 4" lift of 1 1/2"-0" Crushed Rock (approx. 37 CY). Spread 5 CY of 3"-0" Crushed Spot/Base Rock as needed. Spread 5 CY of 1 1/2"-0" Crushed Spot/Cap Rock as needed.	
	89+85	97+69	7+84	6		14'	2'						ABC	A				ASC	C		Renovation. Construct turnouts, turnarounds, ditchouts, and landings (approx. 30' radius). Spread 20 CY of 3"-0" Crushed Spot/Base Rock as needed. Spread 10 CY of 1 1/2"-0" Crushed Spot/Cap Rock as needed. Construct 2 sediment catch basins with straw bales. Install 1 inlet marker.
3-5-29.0	0+00	6+32	6+32	6		14'	2'						ABC	A				ASC	C		Renovation. Construct ditchouts and waste areas as marked. Spread 120 CY of 3"-0" Crushed Spot/Base Rock as marked and needed. Spread 80 CY of 1 1/2"-0" Crushed Spot/Cap Rock as marked and needed. Replace 2 culverts. Install 1 inlet marker.
3-5-29.3	0+00	8+42	8+42	6		14'	2'						ABC	A				ASC	C		Renovation. Construct turnaround and landing (approx. 30' radius) as marked. Spread 150 CY of 3"-0" Crushed Spot/Base Rock as marked and needed. Spread 100 CY of 1 1/2"-0" Crushed Spot/Cap Rock as marked and needed. Place 85 CY of 1 1/2"-0" Crushed Culvert Bedding/Backfill Rock as marked. Excavate failing fill slope material from Sta. 2+24 - 2+57 and use as back fill or haul to designated WA on 3-5-29.0. Construct a stabilization wall on excavated fill slope with 120 CY of Class 3 Rip-Rap @ Sta. 2+46, refer to design notes. Replace existing CMP w/ a 73" x 55" x 52' arch pipe @ Sta. 2+46, refer to design notes. Install 2 culverts. Install 1 inlet marker.
3-5-29.4	0+00	8+15	8+15	6		14'	2'						ABC	A				ASC	C		Renovation. Construct a turnaround as marked. Spread 140 CY of 3"-0" Crushed Spot/Base Rock as marked and needed. Spread 80 CY of 1 1/2"-0" Crushed Spot/Cap Rock as marked and needed. Place 50 CY of 1 1/2"-0" Crushed Culvert Bedding/Backfill Rock as marked. Install 1 sediment catch basin with a straw bale as marked. Install 1 culvert and replace 1 culvert. Install 3 inlet markers.
	8+15	10+11	1+96	5		14'	2'	10%	10%												New Construct. Construct turnout and landing (approx. 30' radius) as marked.

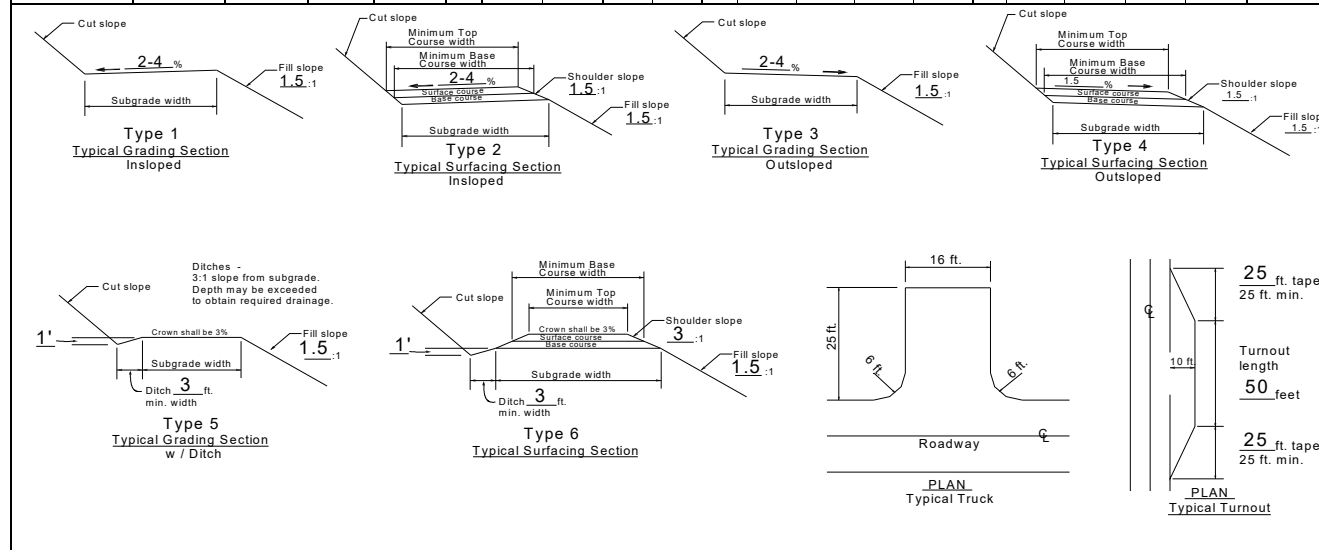

- *NOTES**
- Extra subgrade widths**
Add to each shoulder: 1 ft. for fills of 1-6 ft. and 2 ft. for fills over 6 ft. Widen the inside shoulder of curves as follows:
(See Road Plan Map, Exhibit C)
 - Backslopes**
Materials: Solid rock, Soft rock and shale, Common
Cut slopes: 1/4:1, 1/2:1, 1:1, 3/4:1
Fill slopes: Angle of repose, 1-1/2:1, 1-1/2:1
 - Surface type**
PRR - Pit run rock
GRR - Grid rolled rock
SRN - Screened rock
JRR - Jaw run rock
ABC - Aggr. base course
ASC - Aggr. surface course
WC - Wood chips
Grading: A - 3", B - 2", C - 3" jaw run (base course), D - 1-1/2", E - 1" (surface course)
 - Turnouts**
Width - 10 ft. in addition to subgrade width, or as shown on the plans. Located approximately as shown on the plans. Intervisible and not more than 750 ft. apart.
 - Surfacing**
Turnouts, curve widening and road approach aprons shall be surfaced.
 - Clearing width**
See Section 200
 - As posted and painted for Right-of-Way:
 - Drainage**
See Culvert List
 - Compaction**
See Sections 300 and 400
- Note: Full bench construction is required on side slopes exceeding 60%.
- * Clearing Limits as posted on ground

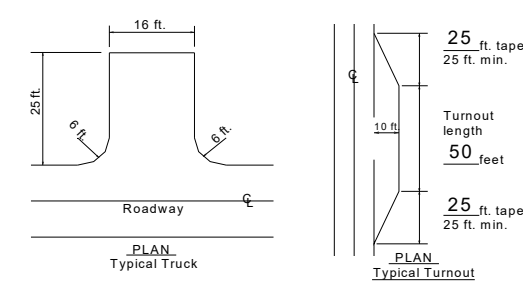

150: ROAD PLAN AND DETAIL SHEET

Road Number	Start Station or Milepost	End Station or Milepost	Total Length	Typical Cross Section	Min. Curve Radius	ROAD WIDTH		GRADIANT		SURFACING (*5)						Remarks		
						Subgrade	Ditch	Max. Favorable	Max. Adverse	BASE COURSE			SURFACE COURSE					
										Min. Width	Comp. Depth	Surface Type (*3)	Grading Size (*3)	Number of Lifts	Min. Width		Comp. Depth	Surface Type (*3)
3-5-29.5	0+00	3+83	3+83	3		14'	0	16%	16%			ABC	A			ASC	C	New Construct. Construct a turnaround and landing (approx. 30' radius) as marked. Spread 20 CY of 3"-0" Crushed Spot/Base Rock as marked. Spread 10 CY of 1 1/2"-0" Crushed Spot/Cap Rock as marked. Excavate into cut bank to allow trucks to make turn onto 3-5-29.6 from Sta. 0+00 - 0+44. Cut and drift material ahead and use as fill at landing @ Sta. 1+64.
3-5-29.6	0+00	5+15		5		14'	2	16%	16%									New Construct. Construct waste area and ditchouts as marked. Create a through cut by cutting and drifting material @ Sta. 0+24 to achieve desired road grade. Construct a full bench road from Sta. 2+86 - 4+04. Haul all excess material to designated WA as directed. Spread 20 CY of 3"-0" Crushed Spot/Base Rock as marked. Spread 15 CY of 1 1/2"-0" Crushed Spot/Cap Rock as marked. Place 20 CY of 1 1/2"-0" Crushed Culvert Bedding/Backfill Rock as marked. Install 1 culvert. Install 1 inlet marker.
	5+15	11+06		3		14'	0	10%	10%			ABC	A			ASC	C	New Construct. Construct a turnaround and landings (approx. 30' radius) as marked.
3-5-29.7	0+00	13+61	13+61	5		14'	2'	16%	16%			ABC	A			ASC	C	New Construct. Construct turnout, turnarounds, waste areas, and landing (approx. 30' radius) as marked. Spread 90 CY of 3"-0" Crushed Spot/Base Rock as marked. Spread 60 CY of 1 1/2"-0" Crushed Spot/Cap Rock as marked. Place 85 CY of 1 1/2"-0" Crushed Culvert Bedding/Backfill Rock as marked. Full bench construction from Sta. 0+06 - 2+84. Haul excess material to designated WA as directed. Construct ditchouts and leadoff ditches as marked. Install 4 culverts. Install 3 inlet markers.
3-5-29.8	0+00	8+69	8+69	5		14'	2'	16%	16%			ABC	A			ASC	C	New Construct. Construct turnaround and landings (approx. 30' radius) as marked. Spread 130 CY of 3"-0" Crushed Spot/Base Rock as marked. Spread 100 CY of 1 1/2"-0" Crushed Spot/Cap Rock as marked and needed. Place 125 CY of 1 1/2"-0" Crushed Culvert Bedding/Backfill Rock. Construct leadoff ditches as marked. Excavate into cut bank and use material on fill slope @ Sta. 0+63. Grade steepens @ Sta. 1+35, cut and drift material ahead to achieve desired road grade. Haul all excess material to designated WA as directed. Install 6 culverts and 1 downspout. Install 4 inlet markers.
Spur A	0+00	3+25	3+25	5		14'	2'	10%	10%			ABC	A			ASC	C	New Construct. Construct landings (approx. 30' radius) as marked. Spread 10 CY of 3"-0" Crushed Spot/Base Rock as marked. Spread 10 CY of 1 1/2"-0" Crushed Spot/Cap Rock as marked. Cut into bank and use as fill material on landing @ Sta. 3+25. Install 1 culvert. Install 1 inlet marker.
Spur B	0+00	3+55	3+55	5		14'	2'	10%	10%			ABC	A			ASC	C	New Construct. Construct landing (approx. 30' radius) as marked. Spread 20 CY of 3"-0" Crushed Spot/Base Rock as marked. Spread 10 CY of 1 1/2"-0" Crushed Spot/Cap Rock as marked. Use suitable local fill material to fill low spot @ Sta. 0+55. Use excess fill material to build up landing surface @ Sta. 3+55.
Spur C	0+00	2+99	2+99	3		14'	0	10%	10%			ABC	A			ASC	C	New Construct. Construct turnout and landing (approx. 30' radius) as marked. Spread 20 CY of 3"-0" Crushed Spot/Base Rock as marked. Spread 10 CY of 1 1/2"-0" Crushed Spot/Cap Rock as marked. Use suitable local fill material to fill low spot @ Sta. 2+17.

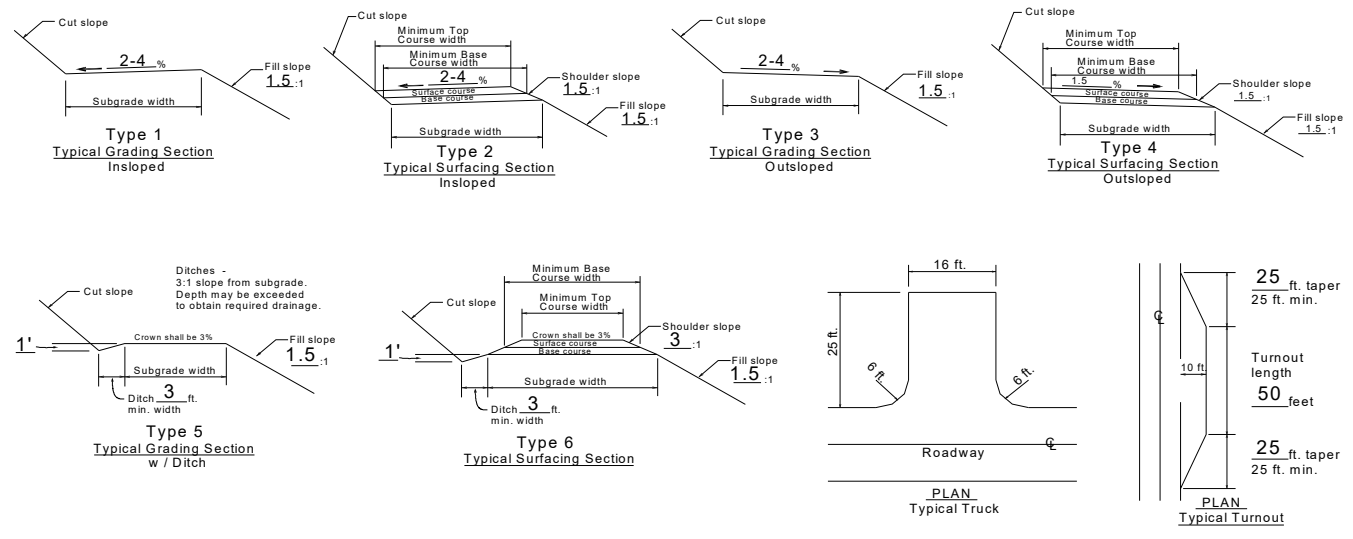

- *NOTES**
- Extra subgrade widths**
Add to each shoulder: 1 ft. for fills of 1-6 ft. and 2 ft. for fills over 6 ft. Widen the inside shoulder of curves as follows:
(See Road Plan Map, Exhibit C)
 - Backslopes**
Materials Cut slopes Fill slopes
Solid rock 1/4:1 Angle of repose
Soft rock and shale 1/2:1
Common
Slopes under 55% 1:1 1-1/2:1
Slopes over 55% 3/4:1 1-1/2:1
 - Surface type**
PRR - Pit run rock Grading A - 3"
GRR - Grid rolled rock B - 2"
SRN - Screened rock C - 3" jaw run (base course)
JRR - Jaw run rock C - 1-1/2"
ABC - Aggr. base course D - 1"
ASC - Aggr. surface course E - 3/4" (surface course)
WC - Wood chips
 - Turnouts**
Width - 10 ft. in addition to subgrade width, or as shown on the plans. Located approximately as shown on the plans. Intervisible and not more than 750 ft. apart.
 - Surfacing**
Turnouts, curve widening and road approach aprons shall be surfaced.
 - Clearing width** 200
See Section
 - As posted and painted for Right-of-Way.
 - Drainage**
See Culvert List
 - Compaction** 300 and 400
See Sections
- * Clearing Limits as posted on ground

U.S. DEPT. OF THE INTERIOR
Bureau of Land Management
NORTHWEST OREGON DISTRICT OFFICE - OREGON
150: ROAD PLAN AND DETAIL SHEET

Road Number	Start Station or Milepost	End Station or Milepost	Total Length	Typical Cross Section	Min. Curve Radius	ROAD WIDTH		GRADIENT			SURFACING (*5)					Remarks					
						Subgrade	Ditch	Max. Favorable	Max. Adverse	Min. Width	Comp. Depth	Surface Type (*3)	Grading Size (*3)	Number of Lifts	Min. Width		Comp. Depth	Surface Type (*3)	Grading Size (*3)	Number of Lifts	
3-5-20.0	0.000	1.866	1.866	6		16'	2'						ABC/PRR	-		12'	4"	ASC	C	1	Renovation. Construct turnouts, waste areas, landings as marked. Spread a 4" lift of 1-1/2"-0" Crushed Rock (approx. 2,101 CY) from MP 0.140 - 1.866. Spread 240 CY of 3"-0" Crushed Base Rock as marked and needed. Spread 180 CY of 1-1/2"-0" Crushed Spot/Cap Rock as marked and needed. Place 170 CY of 1-1/2"-0" Crushed Culvert Bedding/Backfill. Place 25 CY of Class-3 RipRap as marked for fill armor and energy dissipaters. Place 70 CY of Pit Run for 2' x 2' lined ditchlines as marked and 5 CY of Pit Run @ MP. 1.124 to fix catch basin. Install 4 ditchouts as marked. Install 6 sediment catch basins with straw bales as marked. Catch basin is too deep @ MP. 1.495, fix with compacted native soil. Install 1 culvert and replace 8 culverts. Install 18 metal inlet markers.
Rex Brown Rd.	0.000	0.587	0.587	6		18'	2'						ABC	A				ASC	C		Renovation. Construct ditchouts as marked. Spread 20 CY of 3"-0" Crushed Base Rock as marked. Spread 20 CY of 1-1/2"-0" Crushed Spot/Cap Rock as marked. Place 20 CY of 1-1/2"-0" Crushed Culvert Bedding/Backfill Rock. Install 2 sediment catch basins with straw bales as marked. Wrap ditchline around corner into low area @ MP. 0.214. Replace 1 culvert. Re-use 1 inlet marker.

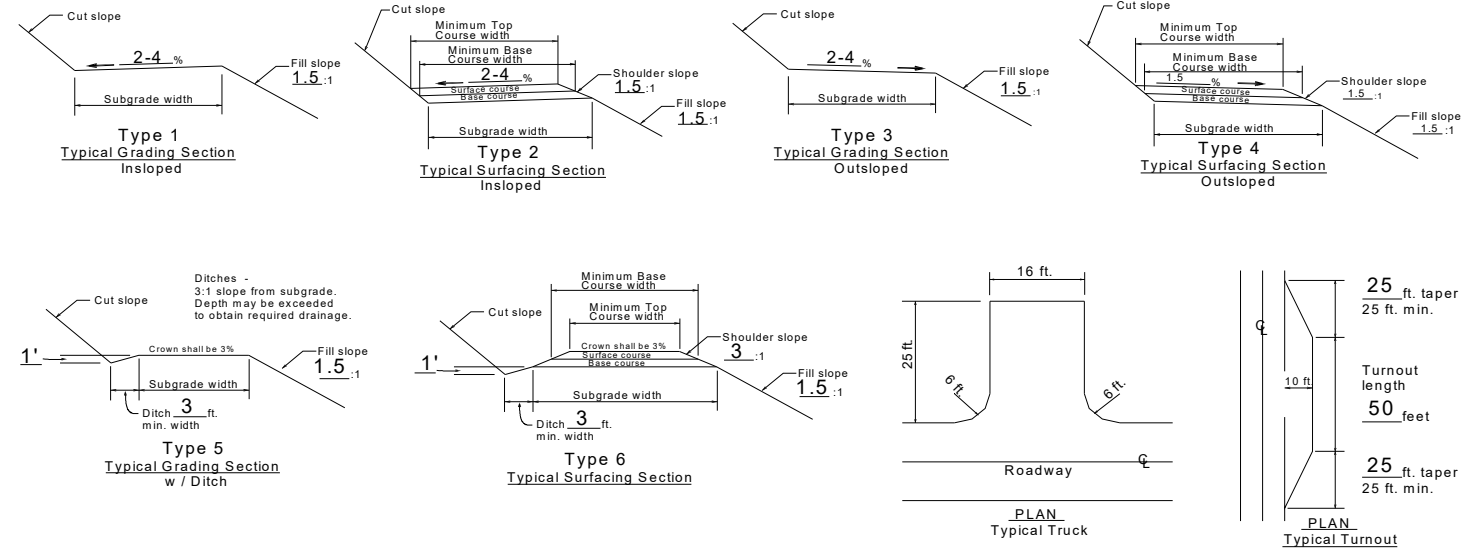

- *NOTES**
- Extra subgrade widths**
Add to each shoulder: 1 ft. for fills of 1-6 ft. and 2 ft. for fills over 6 ft. Widen the inside shoulder of curves as follow:
(See Road Plan Map, Exhibit C)
 - Backslopes**

Materials	Cut slopes	Fill slopes
Solid rock	1/4:1	Angle of repose
Soft rock and shale	1/2:1	
Common		
Slopes under 55%	1:1	1-1/2:1
Slopes over 55%	3/4:1	1-1/2:1

Note:
Full bench construction is required on side slopes exceeding 60%.
 - Surface type**

	Grading	
PRR - Pit run rock	A - 3"	
GRR - Grid rolled rock	B - 2"	(base course)
SRR - Screened rock	C - 3" jaw run	
JRR - Jaw run rock		
ABC - Aggr. base course	C - 1-1/2"	
ASC - Aggr. surface course	D - 1"	(surface course)
WC - Wood chips	E - 3/4"	
 - Turnouts**
Width - 10 ft. in addition to subgrade width, or as shown on the plans.
Located approximately as shown on the plans. Intervisible and not more than 750 ft. apart.
 - Surfacing**
Turnouts, curve widening and road approach aprons shall be surfaced.
 - Clearing width** 200
See Section 200
 - As posted and painted for Right-of-Way:
 - Drainage**
See Culvert List
 - Compaction** 300 and 400
See Sections 300 and 400
- * Clearing Limits as posted on ground

Culvert List

CULVERT LOCATIONS							DOWNSPOUT(d) or STANDPIPE(s) *4				AS BUILT			ROCK RIP RAP (CY)			REMARKS *6
DESIGNED *2														(a) (b)			
Road #	Sta./ M.P	SIZE	GAGE	LENGTH	CULVERT GRADE	INSTALL TYPE *3	SIZE	TYPE	LENGTH	TYPE OF ELBOW *5	SIZE	GAGE	LENGTH	INLET	OUTLET	Structure inside pipe	
3-5-19.1	0+65	18"	--	32'	--	--	--	--	--	--	--	--	--	--	--	--	Replace existing culvert (approx. 3' fill @ CL). Place 15 CY of 1-1/2"-0" Crushed Bedding/Backfill. Surface over pipe with lifts of base and cap rock over whole road. Install metal inlet marker.
	3+03	24"	--	36'	--	--	--	--	--	--	--	--	--	--	10	--	Replace existing culvert (approx. 6' fill @ CL). Place 20 CY of 1-1/2"-0" Crushed Bedding/Backfill. Surface over pipe with lifts of base and cap rock over whole road. Place 10 CY of Class 3 RipRap @ outlet as fill armor. Install metal inlet marker.
	5+76	36"	--	78'	--	--	--	--	--	--	--	--	--	150	--	--	Replace existing culvert (stream crossing, approx. 20' fill @ CL). Place 40 CY of 1-1/2"-0" Crushed Bedding/Backfill. Surface over pipe with lifts of base and cap rock over whole road. Place 150 CY of Class 3 RipRap @ inlet as fill armor. Install metal inlet marker.
	10+66	18"	--	32'	--	--	--	--	--	--	--	--	--	--	--	--	Replace existing culvert (approx. 5' fill @ CL). Place 15 CY of 1-1/2"-0" Crushed Bedding/Backfill. Surface over pipe with lifts of base and cap rock over whole road. Install metal inlet marker.
	14+68	18"	--	34'	--	--	--	--	--	--	--	--	--	--	--	--	Replace existing culvert (approx. 3' fill @ CL). Place 15 CY of 1-1/2"-0" Crushed Bedding/Backfill. Surface over pipe with lifts of base and cap rock over whole road. Install metal inlet marker.
	22+46	18"	--	30'	--	--	--	--	--	--	--	--	--	--	5	--	Replace existing culvert (approx. 4' fill @ CL). Place 10 CY of 1-1/2"-0" Crushed Bedding/Backfill. Surface over pipe with lifts of base and cap rock over whole road. Place 5 CY of Class 3 RipRap @ outlet as energy dissipater. Install metal inlet marker.
	26+08	18"	--	28'	--	--	--	--	--	--	--	--	--	--	--	--	Install New Culvert (approx. 5' fill @ CL) as marked in field. Place 10 CY of 1-1/2"-0" Crushed Bedding/Backfill. Surface over pipe with lifts of base and cap rock over whole road. Install metal inlet marker.
	28+49	36"	--	32'	--	--	--	--	--	--	--	--	--	--	--	--	Replace existing culvert (stream crossing, approx. 6' fill @ CL). Place 15 CY of 1-1/2"-0" Crushed Bedding/Backfill. Surface over pipe with lifts of base and cap rock over whole road. Install metal inlet marker.
	30+44	18"	--	30'	--	--	--	--	--	--	--	--	--	--	--	--	Install New Culvert in ditchline of 3-5-19.1 as marked in field. Place 10 CY 1-1/2"-0" Crushed Bedding/Backfill. Surface over pipe with lifts of base and cap rock over whole road. No metal inlet marker needed.
	31+58	36"	--	92'	--	--	--	--	--	--	--	--	--	--	--	--	Replace existing culvert (stream crossing, approx. 22' fill @ CL). Refer to design notes for construction. Place 50 CY of 1-1/2"-0" Crushed Bedding/Backfill. Surface over pipe with lifts of base and cap rock over whole road. No metal inlet marker needed.
	39+13	24"	12	38'	--	--	--	--	--	--	--	--	--	--	--	--	Install New Perforated Culvert within French Drain (approx. 8' fill CL).Place 50 CY of 1-1/2"-3/4" Crushed Drain Rock. Spread a 6" lift, then install corrugated perforated metal pipe, backfill with remaining rock, and wrap entire French Drain in non-woven geotextile fabric (approx. 1,250 ft ²). Install metal inlet marker.

Gage Chart		
Gage	Dec. Inches	
	Steel	Alum.
10	.138	.135
12	.109	.105
14	.079	.075
16	.064	.060

1. Designed culvert lengths and locations are approximate.

*2. all culverts have 2 2/3" x 1/2"

unless otherwise noted.

**** Corrugated plastic pipe (CPP), Type S (double wall) shall be used for culvert sizes 36" and smaller. All larger culverts shall be aluminized steel. Culverts 20' in length or smaller shall be one piece (no joints). No Culvert piece shall be shorter than 6 foot. Minimization of banding is required.

*4. Downspout or Standpipe Types

- 1) Full *** Downspouts and stand pipes (under 36" diameter) shall be CPP, Type C (single wall).
- 2) Half
- 3) Flume

- *5. 1) Conventional or Fabricated
2) Turner type
3) Slip joint

*6. Include special sections, structures, headwalls, footings & other data.

Culvert List

CULVERT LOCATIONS							DOWNSPOUT(d) or STANDPIPE(s) *4				AS BUILT			ROCK RIP RAP (CY)			REMARKS *6
DESIGNED *2							SIZE	TYPE	LENGTH	TYPE OF ELBOW *5	SIZE	GAGE	LENGTH	INLET	OUTLET	Structure inside pipe	
Road #	Sta./ M.P	SIZE	GAGE	LENGTH	CULVERT GRADE	INSTALL TYPE *3											
3-5-19.1	44+33	42"	14	74'	--	--	--	--	--	--	--	--	--	--	--	--	Replace existing culvert with CMP (stream crossing, approx. 19' fill @ CL). Place 50 CY of 1-1/2"-0" Crushed Bedding/Backfill. Surface over pipe with lifts of base and cap rock over whole road. No metal inlet marker needed.
	47+14	18"	--	50'	--	--	--	--	--	--	--	--	--	--	--	--	Install New Culvert (approx. 5' fill @ CL) as marked in field. Place 20 CY of 1-1/2"-0" Crushed Bedding/Backfill. Surface over pipe with lifts of base and cap rock over whole road. Install metal inlet marker.
	50+79	18"	--	32'	--	--	--	--	--	--	--	--	--	--	--	--	Replace existing culvert (approx. 4' fill @ CL). Place 15 CY of 1-1/2"-0" Crushed Bedding/Backfill. Surface over pipe with lifts of base and cap rock over whole road. Install metal inlet marker.
3-5-19.5	1+88	18"	--	36'	--	--	--	--	--	--	--	--	--	--	--	--	Install New Culvert as marked in field. Place 15 CY of 1-1/2"-0" Crushed Bedding/Backfill. Spread 15 CY of 3"-0" Base Rock over Pipe as Surfacing capped with 10 CY of 1-1/2"-0" Crushed Rock. Install metal inlet marker.
	10+97	18"	--	40'	--	--	--	--	--	--	--	--	--	--	--	--	Install New Culvert as marked in field. Place 20 CY of 1-1/2"-0" Crushed Bedding/Backfill. Spread 20 CY of 3"-0" Base Rock over Pipe as Surfacing capped with 15 CY of 1-1/2"-0" Crushed Rock. Install metal inlet marker.
	11+87	18"	--	60'	--	--	--	--	--	--	--	--	--	--	--	--	Install New Culvert as marked in field (in existing ditchline of 3-5-19.7). Place 20 CY of 1-1/2"-0" Crushed Bedding/Backfill. Spread 20 CY of 3"-0" Base Rock over Pipe as Surfacing capped with 15 CY of 1-1/2"-0" Crushed Rock. No metal inlet marker required.
3-5-19.5A	12+21	18"	--	50'	--	--	--	--	--	--	--	--	--	--	--	--	Install New Culvert as marked in field (in existing ditchline of 3-5-19.7). Place 20 CY of 1-1/2"-0" Crushed Bedding/Backfill. Spread 20 CY of 3"-0" Base Rock over Pipe as Surfacing capped with 15 CY of 1-1/2"-0" Crushed Rock. No metal inlet marker required.
3-5-19.6	0+43	18"	--	70'	--	--	--	--	--	--	--	--	--	--	--	--	Install New Culvert as marked in the field. Place 30 CY of 1-1/2"-0" Crushed Bedding/Backfill. Surface over pipe with lifts of base and cap rock over whole road. No metal inlet marker required.
	13+96	18"	--	40'	--	--	--	--	--	--	--	--	--	--	--	--	Install New Culvert as marked in the field. Place 20 CY of 1-1/2"-0" Crushed Bedding/Backfill. Surface over pipe with lifts of base and cap rock over whole road. Install metal inlet marker.
3-5-19.7	5+60	18"	--	40'	--	--	--	--	--	--	--	--	--	--	--	--	Install New Culvert as marked in the field. Place 20 CY of 1-1/2"-0" Crushed Bedding/Backfill. Spread 20 CY of 3"-0" Base Rock over Pipe as Surfacing capped with 15 CY of 1-1/2"-0" Crushed Rock. Install metal inlet marker.
	8+75	18"	--	36'	--	--	--	--	--	--	--	--	--	--	--	--	Install New Culvert as marked in the field. Place 15 CY of 1-1/2"-0" Crushed Bedding/Backfill. Spread 15 CY of 3"-0" Base Rock over Pipe as Surfacing capped with 10 CY of 1-1/2"-0" Crushed Rock. Install metal inlet marker.

Gage Chart		
Gage	Dec. Inches	
	Steel	Alum.
10	.138	.135
12	.109	.105
14	.079	.075
16	.064	.060

1. Designed culvert lengths and locations are approximate.

*2. all culverts have 2 2/3" x 1/2"

unless otherwise noted.

**** Corrugated plastic pipe (CPP), Type S (double wall) shall be used for culvert sizes 36" and smaller. All larger culverts shall be aluminized steel. Culverts 20' in length or smaller shall be one piece (no joints). No Culvert piece shall be shorter than 6 foot. Minimization of banding is required.

*4. Downspout or Standpipe Types

- 1) Full
- 2) Half
- 3) Flume

*** Downspouts and stand pipes (under 36" diameter) shall be CPP, Type C (single wall).

- *5. 1) Conventional or Fabricated
- 2) Turner type
- 3) Slip joint

*6. Include special sections, structures, headwalls, footings & other data.

Culvert List

CULVERT LOCATIONS							DOWNSPOUT(d) or STANDPIPE(s) *4				AS BUILT			ROCK			REMARKS *6				
DESIGNED *2														RIP RAP (CY)							
Road #	Sta./ M.P	SIZE	GAGE	LENGTH	CULVERT GRADE	INSTALL TYPE *3	SIZE	TYPE	LENGTH	TYPE OF ELBOW *5	SIZE	GAGE	LENGTH	INLET	OUTLET	Structure inside pipe					
3-5-19.8	0+34	18"	--	80'	--	--	--	--	--	--	--	--	--	--	--	--	Install New Culvert as marked in the field (in existing ditchline on 3-5-20.0). Place 35 CY of 1-1/2"-0" Crushed Bedding/Backfill. Surface over pipe with lifts of base and cap rock over whole road. No metal inlet marker required.				
	5+11	18"	--	30'	--	--	--	--	--	--	--	--	--	--	--	--	Install New Culvert as marked in the field. Place 10 CY of 1-1/2"-0" Crushed Bedding/Backfill. Spread 10 CY of 3"-0" Base Rock over Pipe as Surfacing capped with 10 CY of 1-1/2"-0" Crushed Rock. Install metal inlet marker.				
3-5-19.9	0+46	18"	--	50'	--	--	--	--	--	--	--	--	--	--	--	--	Install New Culvert as marked in the field (in ditchline of 3-5-19.8). Place 20 CY of 1-1/2"-0" Crushed Bedding/Backfill. Surface over pipe with lifts of base and cap rock over whole road. No metal inlet marker required.				
	7+57	18"	--	60'	--	--	--	--	--	--	--	--	--	--	--	--	Install New Culvert as marked in the field (in ditchline of 3-5-19.9, perpendicular to turnaround). Place 25 CY of 1-1/2"-0" Crushed Bedding/Backfill. Surface over pipe with lifts of base and cap rock over whole road. No metal inlet marker required.				
	7+95	18"	--	45'	--	--	--	--	--	--	--	--	--	--	--	--	Install New Culvert as marked in the field. Place 20 CY of 1-1/2"-0" Crushed Bedding/Backfill. Surface over pipe with lifts of base and cap rock over whole road. No metal inlet marker required.				
	10+31	18"	--	44'	--	--	--	--	--	--	--	--	--	--	--	--	Install New Culvert as marked in the field. Place 20 CY of 1-1/2"-0" Crushed Bedding/Backfill. Surface over pipe with lifts of base and cap rock over whole road. Install metal inlet marker.				
3-5-19.10	0+24	18"	--	60'	--	--	--	--	--	--	--	--	--	--	--	--	Install New Culvert as marked in the field (in existing ditchline of 3-5-20.0). Place 25 CY of 1-1/2"-0" Crushed Bedding/Backfill. Spread 10 CY of 3"-0" Base Rock over Pipe as Surfacing capped with 10 CY of 1-1/2"-0" Crushed Rock. No inlet marker required.				
3-5-20.1	7+60	--	--	--	--	--	--	--	--	--	--	--	--	--	--	--	Install metal inlet marker on existing CMP.				
	12+21	--	--	--	--	--	--	--	--	--	--	--	--	50	--	--	Place 50 CY of Class 3 RipRap @ inlet for stabilization wall.				
	15+46	--	--	--	--	--	--	--	--	--	--	--	--	--	--	--	Install metal inlet marker on existing CMP.				
	20+21	18"	--	36'	--	--	--	--	--	--	--	--	--	--	--	--	Install New Culvert (approx. 7' fill @ CL) as marked in the field. Place 15 CY 1-1/2"-0" Crushed Bedding/Backfill. Spread 15 CY of 3"-0" Base Rock over Pipe as Surfacing capped with 10 CY of 1-1/2"-0" Crushed Rock. Install metal inlet marker.				
	21+94	--	--	--	--	--	--	--	--	--	--	--	--	--	--	--	Install metal inlet marker on existing CMP.				
	24+17	18"	--	55'	--	--	18"	1	10'	--	--	--	--	5	--	--	Replace existing culvert (approx. 13' fill @ CL). Place 25 CY of 1-1/2"-0" Crushed Bedding/Backfill. Spread 25 CY of 3"-0" Base Rock over Pipe as Surfacing capped with 20 CY of 1-1/2"-0" Crushed Rock. Place 5 CY of Class 3 RipRap @ inlet as fill armor. Install metal inlet marker.				
	30+23	--	--	--	--	--	--	--	--	--	--	--	--	--	--	--	Install metal inlet marker on existing CMP.				
	39+89	24"	12	50'	--	--	--	--	--	--	--	--	--	--	140	--	Replace existing culvert with a French Drain that has a corrugated metal perforated pipe (approx. 10' fill @ CL). Place 230 CY of 1-1/2"-3/4" Crushed Drain Rock. Spread a 6" lift, then install corrugated metal perforated pipe, backfill with remaining rock, and wrap entire French Drain in non-woven geotextile fabric (approx. 5,500 ft2). Construct a stabilization wall on the outlet fill slope with 140 CY of Class 5 RipRap. Dimensions marked in the field				
	41+23	18"	--	34'	--	--	--	--	--	--	--	--	--	--	--	--	Install New Culvert as marked in the field. Place 15 CY of 1-1/2"-0" Crushed Bedding/Backfill. Spread 15 CY of 3"-0" Base Rock over Pipe as Surfacing capped with 10 CY of 1-1/2"-0" Crushed Rock. Install metal inlet marker.				
	43+70	--	--	--	--	--	--	--	--	--	--	--	--	--	--	--	Install metal inlet maker on existing CMP.				
		Gage Chart			<p>1. Designed culvert lengths and locations are approximate.</p> <p>*2. all culverts have 2 2/3" x 1/2" unless otherwise noted.</p> <p>*3. Downspout or Standpipe Types</p> <p>1) Full *** Downspouts and stand pipes (under 36" diameter) shall be CPP, Type C (single wall).</p> <p>2) Half</p> <p>3) Flume</p> <p>*4. Downspout or Standpipe Types</p> <p>1) Full *** Downspouts and stand pipes (under 36" diameter) shall be CPP, Type C (single wall).</p> <p>2) Half</p> <p>3) Flume</p> <p>*5. 1) Conventional or Fabricated 2) Turner type 3) Slip joint</p> <p>*6. Include special sections, structures, headwalls, footings & other data.</p> <p>**** Corrugated plastic pipe (CPP), Type S (double wall) shall be used for culvert sizes 36" and smaller. All larger culverts shall be aluminized steel. Culverts 20' in length or smaller shall be one piece (no joints). No Culvert piece shall be shorter than 6 foot. Minimization of banding is required.</p>																
		<table border="1"> <tr> <td rowspan="2">Gage</td> <td colspan="2">Dec. Inches</td> </tr> <tr> <td>Steel</td> <td>Alum.</td> </tr> <tr> <td>10</td> <td>.138</td> <td>.135</td> </tr> <tr> <td>12</td> <td>.109</td> <td>.105</td> </tr> <tr> <td>14</td> <td>.079</td> <td>.075</td> </tr> <tr> <td>16</td> <td>.064</td> <td>.060</td> </tr> </table>			Gage	Dec. Inches		Steel	Alum.	10	.138	.135	12	.109	.105	14	.079	.075	16	.064	.060
Gage	Dec. Inches																				
	Steel	Alum.																			
10	.138	.135																			
12	.109	.105																			
14	.079	.075																			
16	.064	.060																			

Culvert List

CULVERT LOCATIONS							DOWNSPOUT(d) or STANDPIPE(s) *4				AS BUILT			ROCK			REMARKS *6
DESIGNED *2														RIP RAP (GRADING)			
														(a) (b)			
Road #	Sta./ M.P	SIZE	GAGE	LENGTH	CULVERT GRADE	INSTALL TYPE *3	SIZE	TYPE	LENGTH	TYPE OF ELBOW *5	SIZE	GAGE	LENGTH	INLET	OUTLET	Structure inside pipe	
3-5-20.1	51+05	36"	--	60'	--	--	--	--	--	--	--	--	--	--	--	--	Replace existing culvert (stream crossing, approx. 10' fill @ CL). Place 35 CY of 1-1/2"-0" Crushed Bedding/Backfill. Surface over pipe with lifts of base and cap rock over portion of road. Install metal inlet marker.
	52+35	18"	--	55'	--	--	--	--	--	--	--	--	--	--	--	--	Install New Culvert as marked in the field. Place 20 CY of 1-1/2"-0" Crushed Bedding/Backfill. Spread 20 CY of 3"-0" Base Rock over Pipe as Surfacing capped with 15 CY of 1-1/2"-0" Crushed Rock. Install metal inlet marker.
	54+91	18"	--	50'	--	--	--	--	--	--	--	--	--	--	--	--	Install New Culvert as marked in the field. Place 20 CY of 1-1/2"-0" Crushed Bedding/Backfill. Spread 20 CY of 3"-0" Base Rock over Pipe as Surfacing capped with 15 CY of 1-1/2"-0" Crushed Rock. Install metal inlet marker.
	57+31	--	--	--	--	--	--	--	--	--	--	--	--	--	--	--	Install metal inlet marker on existing CMP.
	65+39	--	--	--	--	--	--	--	--	--	--	--	--	--	--	--	Install metal inlet marker on existing CMP.
	69+88	18"	--	40'	--	--	--	--	--	--	--	--	--	--	--	--	Install New Culvert as marked in the field. Place 20 CY of 1-1/2"-0" Crushed Bedding/Backfill. Spread 20 CY of 3"-0" Base Rock over Pipe as Surfacing capped with 15 CY of 1-1/2"-0" Crushed Rock. Install metal inlet marker.
	71+89	18"	--	45'	--	--	--	--	--	--	--	--	--	--	--	--	Install New Culvert as marked in the field. Place 20 CY of 1-1/2"-0" Crushed Bedding/Backfill. Spread 20 CY of 3"-0" Base Rock over Pipe as Surfacing capped with 15 CY of 1-1/2"-0" Crushed Rock. Install metal inlet marker.
	74+92	18"	--	45'	--	--	--	--	--	--	--	--	--	--	--	--	Replace existing culvert. Place 20 CY of 1-1/2"-0" Crushed Bedding/Backfill. Spread 20 CY of 3"-0" Base Rock over Pipe as Surfacing capped with 15 CY of 1-1/2"-0" Crushed Rock. Install metal inlet marker.
	83+72	18"	--	40'	--	--	--	--	--	--	--	--	--	--	--	--	Install New Culvert as marked in the field. Place 20 CY of 1-1/2"-0" Crushed Bedding/Backfill. Spread 20 CY of 3"-0" Base Rock over Pipe as Surfacing capped with 15 CY of 1-1/2"-0" Crushed Rock. Install metal inlet marker.
	87+85	18"	--	45'	--	--	--	--	--	--	--	--	--	--	--	--	Install New Culvert as marked in the field. Place 20 CY of 1-1/2"-0" Crushed Bedding/Backfill. Spread 20 CY of 3"-0" Base Rock over Pipe as Surfacing capped with 15 CY of 1-1/2"-0" Crushed Rock. Install metal inlet marker.
	92+60	--	--	--	--	--	--	--	--	--	--	--	--	--	--	--	Install metal inlet marker on existing CMP.

Gage Chart		
Gage	Dec. Inches	
	Steel	Alum.
10	.138	.135
12	.109	.105
14	.079	.075
16	.064	.060

1. Designed culvert lengths and locations are approximate.

*2. all culverts have 2 2/3" x 1/2"

unless otherwise noted.

**** Corrugated plastic pipe (CPP), Type S (double wall) shall be used for culvert sizes 36" and smaller. All larger culverts shall be aluminized steel. Culverts 20' in length or smaller shall be one piece (no joints). No Culvert piece shall be shorter than 6 foot. Minimization of banding is required.

*4. Downspout or Standpipe Types

- 1) Full
- 2) Half
- 3) Flume

*** Downspouts and stand pipes (under 36" diameter) shall be CPP, Type C (single wall).

- *5. 1) Conventional or Fabricated
- 2) Turner type
- 3) Slip joint

*6. Include special sections, structures, headwalls, footings & other data.

Culvert List

CULVERT LOCATIONS							DOWNSPOUT(d) or STANDPIPE(s) *4				AS BUILT			ROCK			REMARKS *6
DESIGNED *2														RIP RAP (GRADING)			
Road #	Sta./ M.P	SIZE	GAGE	LENGTH	CULVERT GRADE	INSTALL TYPE *3	SIZE	TYPE	LENGTH	TYPE OF ELBOW *5	SIZE	GAGE	LENGTH	INLET	OUTLET	Structure inside pipe	
3-5-29.0	0+18	--	--	--	--	--	--	--	--	--	--	--	--	--	--	--	Install metal inlet marker on existing CMP.
	1+33	36"	--	55'	--	--	--	--	--	--	--	--	--	--	--	--	Replace existing culvert (stream crossing, approx. 11' fill @ CL). Place 30 CY of 1-1/2"-0" Crushed Bedding/Backfill. Spread 25 CY of 3"-0" Base Rock over Pipe as Surfacing capped with 20 CY of 1-1/2"-0" Crushed Rock. No metal inlet marker required.
	2+80	36"	--	60'	--	--	--	--	--	--	--	--	--	--	5	--	Replace existing culvert (stream crossing, approx. 15' fill @ CL). Place 35 CY of 1-1/2"-0" Crushed Bedding/Backfill. Spread 30 CY of 3"-0" Base Rock over Pipe as Surfacing capped with 20 CY of 1-1/2"-0" Crushed Rock. Place 5 CY of Class 3 RipRap @outlet for energy dissipater. No metal inlet marker required.
3-5-29.3	2+46	73" x 55"	12	52'	--	--	--	--	--	--	--	--	--	--	120	--	Replace existing culvert with arch pipe (stream crossing, approx. 10' fill @ CL). Place 50 CY of 1-1/2"-0" Crushed Bedding/Backfill. Spread 35 CY of 3"-0" Base Rock over Pipe as Surfacing capped with 25 CY of 1-1/2"-0" Crushed Rock. Place 120 CY of Class 3 RipRap @ outlet on fill slope for stabilization wall. No metal inlet marker required.
	3+85	18"	--	34'	--	--	--	--	--	--	--	--	--	--	--	--	Install New Culvert as marked in field. Place 15 CY of 1-1/2"-0" Crushed Bedding/Backfill. Spread 15 CY of 3"-0" Base Rock over Pipe as Surfacing capped with 10 CY of 1-1/2"-0" Crushed Rock. Install metal inlet marker.
	5+60	18"	--	40'	--	--	--	--	--	--	--	--	--	--	--	--	Install New Culvert as marked in field (in existing ditchline of 3-5-29.3). Place 20 CY of 1-1/2"-0" Crushed Bedding/Backfill. Spread 20 CY of 3"-0" Base Rock over Pipe as Surfacing capped with 15 CY of 1-1/2"-0" Crushed Rock. No metal inlet marker required.
3-5-29.4	0+24	--	--	--	--	--	--	--	--	--	--	--	--	--	--	--	Install metal inlet marker on existing CMP.
	1+44	36"	--	60'	--	--	--	--	--	--	--	--	--	--	--	--	Replace existing culvert (stream crossing, approx. 13' fill @ CL). Place 35 CY of 1-1/2"-0" Crushed Bedding/Backfill. Spread 30 CY of 3"-0" Base Rock over Pipe as Surfacing capped with 20 CY of 1-1/2"-0" Crushed Rock. Install metal inlet marker.

Gage Chart		
Gage	Dec. Inches	
	Steel	Alum.
10	.138	.135
12	.109	.105
14	.079	.075
16	.064	.060

1. Designed culvert lengths and locations are approximate.

*2. all culverts have 2 2/3" x 1/2". Corrugations on Arch-Pipes to have 3" x 1" corrugations.

unless otherwise noted.

**** Corrugated plastic pipe (CPP), Type S (double wall) shall be used for culvert sizes 36" and smaller. All larger culverts shall be aluminized steel. Culverts 20' in length or smaller shall be one piece (no joints). No Culvert piece shall be shorter than 6 foot. Minimization of banding is required.

*4. Downspout or Standpipe Types

- 1) Full
- 2) Half
- 3) Flume

*** Downspouts and stand pipes (under 36" diameter) shall be CPP, Type C (single wall).

*5. 1) Conventional or Fabricated
 2) Turner type
 3) Slip joint

*6. Include special sections, structures, headwalls, footings & other data.

Culvert List

CULVERT LOCATIONS							DOWNSPOUT(d) or STANDPIPE(s) *4				AS BUILT			ROCK			REMARKS *6
DESIGNED *2														RIP RAP (GRADING)			
														(a) (b)			
Road #	Sta./ M.P	SIZE	GAGE	LENGTH	CULVERT GRADE	INSTALL TYPE *3	SIZE	TYPE	LENGTH	TYPE OF ELBOW *5	SIZE	GAGE	LENGTH	INLET	OUTLET	Structure inside pipe	
3-5-29.4 (cont.)	4+31	18"	--	34'	--	--	--	--	--	--	--	--	--	--	--	--	Install New Culvert as marked in field. Place 15 CY of 1-1/2"-0" Crushed Bedding/Backfill. Spread 15 CY of 3"-0" Base Rock over the Pipe as Surfacing capped with 10 CY of 1-1/2"-0" Crushed Rock. Install metal inlet marker.
3-5-29.6	5+15	18"	--	40'	--	--	--	--	--	--	--	--	--	--	--	--	Install New Culvert with a leadoff ditch as marked in field. Place 20 CY of 1-1/2"-0" Crushed Bedding/Backfill. Spread 20 CY of 3"-0" Base Rock over the Pipe as Surfacing capped with 15 CY of 1-1/2"-0" Crushed Rock. Install metal inlet marker.
3-5-29.7	0+00	18"	--	70'	--	--	--	--	--	--	--	--	--	--	--	--	Install New Culvert as marked in the field (in existing ditchline of 3-5-20.1). Place 30 CY of 1-1/2"-0" Crushed Bedding/Backfill. Spread 15 CY of 3"-0" Base Rock over the Pipe as Surfacing capped with 10 CY of 1-1/2"-0" Crushed Rock. No metal inlet marker required.
	3+78	18"	--	50'	--	--	--	--	--	--	--	--	--	--	--	--	Install New Culvert with a leadoff ditch as marked in the field. Place 20 CY of 1-1/2"-0" Crushed Bedding/Backfill. Spread 20 CY of 3"-0" Base Rock over the Pipe as Surfacing capped with 15 CY of 1-1/2"-0" Crushed Rock. Install metal inlet marker.
	9+03	18"	--	45'	--	--	--	--	--	--	--	--	--	--	--	--	Install New Culvert as marked in the field. Place 20 CY of 1-1/2"-0" Crushed Bedding/Backfill. Spread 20 CY of 3"-0" Base Rock over the Pipe as Surfacing capped with 15 CY of 1-1/2"-0" Crushed Rock. Install metal inlet marker.
	11+99	18"	--	35'	--	--	--	--	--	--	--	--	--	--	--	--	Install New Culvert as marked in the field. Place 15 CY of 1-1/2"-0" Crushed Bedding/Backfill. Spread 15 CY of 3"-0" Base Rock over the Pipe as Surfacing capped with 10 CY of 1-1/2"-0" Crushed Rock. Install metal inlet marker.
3-5-29.8	0+22	18"	--	60'	--	--	--	--	--	--	--	--	--	--	--	--	Install New Culvert with a leadoff ditch as marked in the field (in existing ditchline of 3-5-20.1). Place 25 CY of 1-1/2"-0" Crushed Bedding/Backfill. Spread 10 CY of 3"-0" Base Rock over the Pipe as Surfacing capped with 10 CY of 1-1/2"-0" Crushed Rock. No metal inlet marker required.
	2+82	18"	--	56'	--	--	18"	1	10'	--	--	--	--	--	--	--	Install New Culvert and downspout as marked in the field. Place 20 CY of 1-1/2"-0" Crushed Bedding/Backfill. Spread 20 CY" of 3"-0" Base Rock over the Pipe as Surfacing capped with 15 CY of 1-1/2"-0" Crushed Rock. Install metal inlet marker.

Gage Chart		
Gage	Dec. Inches	
	Steel	Alum.
10	.138	.135
12	.109	.105
14	.079	.075
16	.064	.060

1. Designed culvert lengths and locations are approximate.

*2. all culverts have 2 2/3" x 1/2"

unless otherwise noted.

**** Corrugated plastic pipe (CPP), Type S (double wall) shall be used for culvert sizes 36" and smaller. All larger culverts shall be aluminized steel. Culverts 20' in length or smaller shall be one piece (no joints). No Culvert piece shall be shorter than 6 foot. Minimization of banding is required.

*4. Downspout or Standpipe Types

- 1) Full
- 2) Half
- 3) Flume

*** Downspouts and stand pipes (under 36" diameter) shall be CPP, Type C (single wall).

*5. 1) Conventional or Fabricated

- 2) Turner type
- 3) Slip joint

*6. Include special sections, structures, headwalls, footings & other data.

Culvert List

CULVERT LOCATIONS							DOWNSPOUT(d) or STANDPIPE(s) *4				AS BUILT			ROCK			REMARKS *6
DESIGNED *2														RIP RAP (GRADING)			
														(a) (b)			
Road #	Sta./ M.P	SIZE	GAGE	LENGTH	CULVERT GRADE	INSTALL TYPE *3	SIZE	TYPE	LENGTH	TYPE OF ELBOW *5	SIZE	GAGE	LENGTH	INLET	OUTLET	Structure inside pipe	
3-5-29.8	4+38	18"	--	50'	--	--	--	--	--	--	--	--	--	--	--	--	Install New Culvert as marked in the field. Place 20 CY of 1-1/2"-0" Crushed Bedding/Backfill. Spread 20 CY of 3"-0" Base Rock over the Pipe as Surfacing capped with 15 CY of 1-1/2"-0" Crushed Rock. Install metal inlet marker.
	4+90	18"	--	40'	--	--	--	--	--	--	--	--	--	--	--	--	Install New Culvert as marked in the field (in ditchline, perpendicular to turnaround). Place 20 CY of 1-1/2"-0" Crushed Bedding/Backfill. Spread 20 CY of 3"-0" Base Rock over the Pipe as Surfacing capped with 15 CY of 1-1/2"-0" Crushed Rock. No metal inlet marker required.
	5+85	18"	--	45'	--	--	--	--	--	--	--	--	--	--	--	--	Install New Culvert as marked in the field. Place 20 CY of 1-1/2"-0" Crushed Bedding/Backfill. Spread 20 CY of 3"-0" Base Rock over the Pipe as Surfacing capped with 15 CY of 1-1/2"-0" Crushed Rock. Install metal inlet marker.
	7+58	18"	--	45'	--	--	--	--	--	--	--	--	--	--	--	--	Install New Culvert as marked in the field. Place 20 CY of 1-1/2"-0" Crushed Bedding/Backfill. Spread 20 CY of 3"-0" Base Rock over the Pipe as Surfacing capped with 15 CY of 1-1/2"-0" Crushed Rock. Install metal inlet marker.
Spur A	1+83	18"	--	30'	--	--	--	--	--	--	--	--	--	--	--	--	Install New Culvert as marked in the field. Place 10 CY of 1-1/2"-0" Crushed Bedding/Backfill. Spread 10 CY of 3"-0" Base Rock over the Pipe as Surfacing capped with 10 CY of 1-1/2"-0" Crushed Rock. Install metal inlet marker.
3-5-20.0	0.140	--	--	--	--	--	--	--	--	--	--	--	--	--	--	--	Install metal inlet marker on existing CPP.
	0.181	--	--	--	--	--	--	--	--	--	--	--	--	--	--	--	Install metal inlet marker on existing CPP.
	0.248	18"	--	40'	--	--	--	--	--	--	--	--	--	--	--	--	Replace existing culvert. Place 20 CY of 1-1/2"-0" Crushed Bedding/Backfill. Spread 20 CY of 3"-0" Base Rock over the Pipe as Surfacing capped with a lift of rock over whole road. Install metal inlet marker.
	0.327	--	--	--	--	--	--	--	--	--	--	--	--	--	--	--	Install metal inlet marker on existing CMP.

Gage Chart		
Gage	Dec. Inches	
	Steel	Alum.
10	.138	.135
12	.109	.105
14	.079	.075
16	.064	.060

1. Designed culvert lengths and locations are approximate.

***2.** all culverts have 2 2/3" x 1/2"

unless otherwise noted.

**** Corrugated plastic pipe (CPP), Type S (double wall) shall be used for culvert sizes 36" and smaller. All larger culverts shall be aluminized steel. Culverts 20' in length or smaller shall be one piece (no joints). No Culvert piece shall be shorter than 6 foot. Minimization of banding is required.

***4.** Downspout or Standpipe Types

- 1) Full
- 2) Half
- 3) Flume

*** Downspouts and stand pipes (under 36" diameter) shall be CPP, Type C (single wall).

- *5.** 1) Conventional or Fabricated
 2) Turner type
 3) Slip joint

***6.** Include special sections, structures, headwalls, footings & other data.

Culvert List

CULVERT LOCATIONS							DOWNSPOUT(d) or STANDPIPE(s) *4				AS BUILT			ROCK			REMARKS *6
DESIGNED *2														RIP RAP (GRADING)			
Road #	Sta./ M.P	SIZE	GAGE	LENGTH	CULVERT GRADE	INSTALL TYPE *3	SIZE	TYPE	LENGTH	TYPE OF ELBOW *5	SIZE	GAGE	LENGTH	INLET	OUTLET	Structure inside pipe	
3-5-20.0 (Cont.)	0.375	48"	14	50'	--	--	--	--	--	--	--	--	--	5	15	--	Replace existing culvert (stream crossing, approx. 10' fill @ CL). Place 40 CY of 1-1/2"-0" Crushed Bedding/Backfill. Spread 30 CY of 3"-0" Base Rock over Pipe as Surfacing capped with lift of rock over whole road. Place 5 CY of Class-3 RipRap @ inlet as fill armor. Place 15 CY of Class-3 RipRap @ outlet as energy dissipater and fill armor. Install metal inlet marker.
	0.468	--	--	--	--	--	--	--	--	--	--	--	--	--	--	--	Install metal inlet marker on existing CPP.
	0.604	18"	--	40'	--	--	--	--	--	--	--	--	--	--	5	--	Replace existing culvert. Place 20 CY of 1-1/2"-0" Crushed Bedding/Backfill. Spread 20 CY of 3"-0" Base Rock over Pipe as Surfacing capped with lift of rock over whole road. Place 5 CY of Class-3 RipRap @ outlet as energy dissipater. Install metal inlet marker.
	0.704	18"	--	40'	--	--	--	--	--	--	--	--	--	--	--	--	Replace existing culvert. Place 20 CY of 1-1/2"-0" Crushed Bedding/Backfill. Spread 20 CY of 3"-0" Base Rock over Pipe as Surfacing capped with lift of rock over whole road. Install metal inlet marker.
	0.833	--	--	--	--	--	--	--	--	--	--	--	--	--	--	--	Install metal inlet marker on existing CPP.
	0.947	18"	--	36'	--	--	--	--	--	--	--	--	--	--	--	--	Replace existing culvert. Place 15 CY of 1-1/2"-0" Crushed Bedding/Backfill. Spread 15 CY of 3"-0" Base Rock over Pipe as Surfacing capped with lift of rock over whole road. Install metal inlet marker.
	1.036	--	--	--	--	--	--	--	--	--	--	--	--	--	--	--	Install metal inlet marker on existing CMP.
	1.124	--	--	--	--	--	--	--	--	--	--	--	--	--	--	--	Install metal inlet marker on existing CMP. Place 5 CY of Pit Run to fix catch basin sides.
	1.250	--	--	--	--	--	--	--	--	--	--	--	--	--	--	--	Install metal inlet marker on existing CPP.
	1.495	--	--	--	--	--	--	--	--	--	--	--	--	--	--	--	Install metal inlet marker on existing CPP. Catch basin is too deep, fix with compacted native soil.
	1.564	18"	--	30'	--	--	--	--	--	--	--	--	--	--	--	--	Replace existing culvert. Place 10 CY of 1-1/2"-0" Crushed Bedding/Backfill. Spread 10 CY of 3"-0" Base Rock over Pipe as Surfacing capped with lift of rock over whole road. Install metal inlet marker.
	1.689	18"	--	34'	--	--	--	--	--	--	--	--	--	--	--	--	Install New Culvert as marked in the field. Place 15 CY of 1-1/2"-0" Crushed Bedding/Backfill. Spread 15 CY of 3"-0" Base Rock over Pipe as Surfacing capped with lift of rock over whole road. Install metal inlet marker.
	1.761	18"	--	36'	--	--	--	--	--	--	--	--	--	--	--	--	Replace existing culvert. Place 15 CY of 1-1/2"-0" Crushed Bedding/Backfill. Spread 15 CY of 3"-0" Base Rock over Pipe as Surfacing capped with lift of rock over whole road. Install metal inlet marker.
	1.825	18"	--	36'	--	--	--	--	--	--	--	--	--	--	--	--	Replace existing culvert. Place 15 CY of 1-1/2"-0" Crushed Bedding/Backfill. Spread 15 CY of 3"-0" Base Rock over Pipe as Surfacing capped with lift of rock over whole road. Install metal inlet marker.

Gage Chart		
Gage	Dec. Inches	
	Steel	Alum.
10	.138	.135
12	.109	.105
14	.079	.075
16	.064	.060

1. Designed culvert lengths and locations are approximate.
 *2. all culverts have 2 2/3" x 1/2" unless otherwise noted.

*4. Downspout or Standpipe Types
 1) Full
 2) Half
 3) Flume

*** Downspouts and stand pipes (under 36" diameter) shall be CPP, Type C (single wall).

*5. 1) Conventional or Fabricated
 2) Turner type
 3) Slip joint

*6. Include special sections, structures, headwalls, footings & other data.

**** Corrugated plastic pipe (CPP), Type S (double wall) shall be used for culvert sizes 36" and smaller. All larger culverts shall be aluminized steel. Culverts 20' in length or smaller shall be one piece (no joints). No Culvert piece shall be shorter than 6 foot. Minimization of banding is required.

Culvert List

CULVERT LOCATIONS							DOWNSPOUT(d) or STANDPIPE(s) *4				AS BUILT			ROCK			REMARKS *6
DESIGNED *2														RIP RAP (GRADING)			
														(a) (b)			
Road #	Sta./ M.P	SIZE	GAGE	LENGTH	CULVERT GRADE	INSTALL TYPE *3	SIZE	TYPE	LENGTH	TYPE OF ELBOW *5	SIZE	GAGE	LENGTH	INLET	OUTLET	Structure inside pipe	
Rex Brown Road	0.587	18"	--	40'	--	--	--	--	--	--	--	--	--	--	--	--	Replace existing culvert. Place 20 CY of 1-1/2"-0" Crushed Bedding/Backfill. Spread 20 CY of 3"-0" Base Rock over Pipe as Surfacing capped with 20 CY of 1-1/2"-0" Crushed Rock. Re-use metal inlet marker.

Gage Chart		
Gage	Dec. Inches	
	Steel	Alum.
10	.138	.135
12	.109	.105
14	.079	.075
16	.064	.060

1. Designed culvert lengths and locations are approximate.

*2. all culverts have 2 2/3" x 1/2"

unless otherwise noted.

**** Corrugated plastic pipe (CPP), Type S (double wall) shall be used for culvert sizes 36" and smaller. All larger culverts shall be aluminized steel. Culverts 20' in length or smaller shall be one piece (no joints). No Culvert piece shall be shorter than 6 foot. Minimization of banding is required.

*4. Downspout or Standpipe Types

- 1) Full
- 2) Half
- 3) Flume

*** Downspouts and stand pipes (under 36" diameter) shall be CPP, Type C (single wall).

*5. 1) Conventional or Fabricated
 2) Turner type
 3) Slip joint

*6. Include special sections, structures, headwalls, footings & other data.

U.S. DEPT. OF THE INTERIOR
 Bureau of Land Management
 NORTHWEST OREGON DISTRICT OFFICE - OREGON
CULVERT BAND DETAILS

NOTE:
 DESIGN VARIATIONS IN FASTENERS,
 (STRAPS, BARS & WELDS) WHICH
 PROVIDE A TENSILE STRENGTH OF
 7500 LBS. ARE PERMISSIBLE.

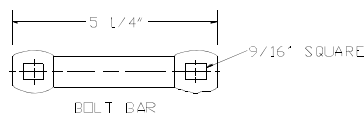
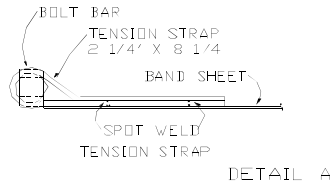

TENSION STRAP
 AND BOLT BAR.
 SEE DETAIL A.

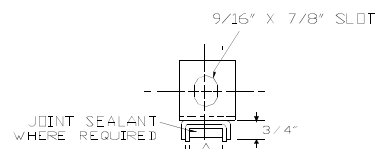
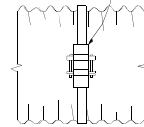

DIMENSIONS IN INCHES

T	A	PIPE WALL THICKNESS
.879	3/4	.09 OR LIGHTER
.109	1	.08 OR HEAVIER

SECTION A-A

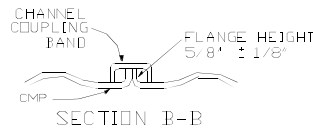
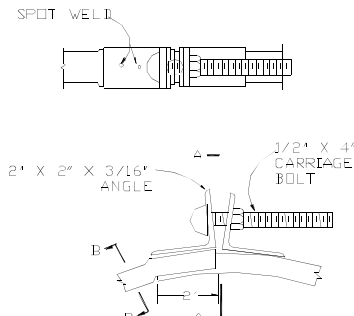

CHANNEL
 BAND
 COUPLER

NOTE:
 AS AN ALTERNATE TO SWEDGE, AN
 OVERSIZE BRIDGE CLIP MAY BE USED.

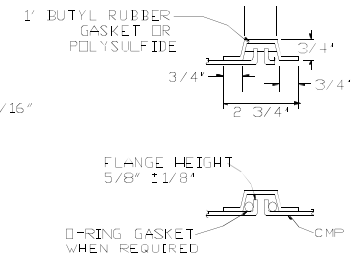
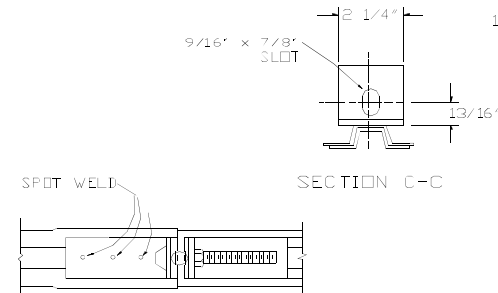

SECTION D-D
 SHOWN WITH ALTERNATE TYPES
 OF JOINT SEALERS

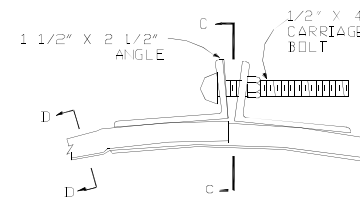

FLANGED END COUPLER

CULVERT SIZE INCHES	STANDARD COUPLER BANDS								
	CORRUGATED				SMOOTH				
	STD. ANNULAR	HELIICAL	3\"/>						
UNDER 18	7	2	7	2	3	14	3	18	3
18 TO 54	12	3	12	3	14	3	18	3	3
OVER 54	24	5	24	5	24	5	24	4	4

DATA IN THIS BLOCK DOES NOT APPLY TO PERFORATED PIPE UNDERDRAIN.
 FOR BANDS WITH "PUNCH-OUT" TYPE CONNECTIONS, 2 BOLTS ARE
 PERMISSIBLE FOR EACH LAP. BANDS SHALL LAP 1/2 WIDTH ONTO EACH
 SECTION OF PIPE AND MUST FULLY ENCLOSE THE JOINT FORMING A
 NEARLY WATER-TIGHT CONNECTION.

- (A) BANDS WITH ANGLES
- (B) BANDS WITH TENSION TYPE CONNECTIONS

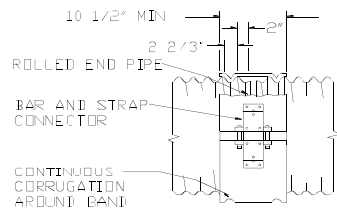

THE HUGGER COUPLER BAND OR AN APPROVED EQUIVALENT
 COUPLER BAND SHALL BE MADE OF THE SAME MATERIAL AND
 FINISH AS THE PIPES JOINED. THE COUPLER BANDS SHALL
 HAVE A MINIMUM WIDTH OF 10 1/2 INCHES AND MAY BE TWO
 NUMERICAL THICKNESSES LIGHTER THAN THE GAGE OR
 THICKNESS DESIGNATED FOR THE CONDUIT JOINED. THE BAND
 SHALL BE DESIGNED TO BE DRAWN TOGETHER WITH TWO
 1/2 INCH BOLTS THROUGH USE OF A BAR AND STRAP SUITABLY
 WELDED TO THE BAND. THE BAND SHALL ENGAGE AND MESH
 WITH THE SECOND ANNULAR CORRUGATION INWARD FROM
 THE END OF EACH OF THE CONDUIT SECTIONS JOINED.

STANDARD CONSTRUCTION IS 1 PIECE 12'
 THRU 48' AND 2 PIECE 54' AND ABOVE

GASKETS AND "HUGGER" TYPE BANDS, OR AN APPROVED
 EQUIVALENT COUPLER, SHALL BE INSTALLED
 INSTALLED ON ALL 48" AND LARGER METAL PIPES.

"HUGGER" COUPLER BANDS

U.S. DEPT. OF THE INTERIOR
 Bureau of Land Management
 NORTHWEST OREGON DISTRICT OFFICE - OREGON
CULVERT INSTALLATION DETAILS

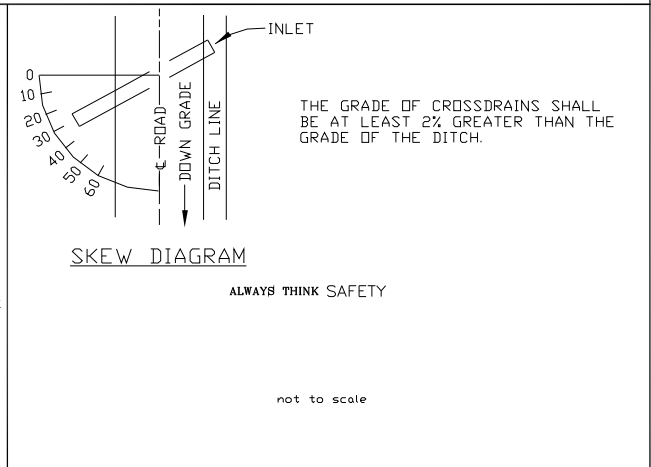
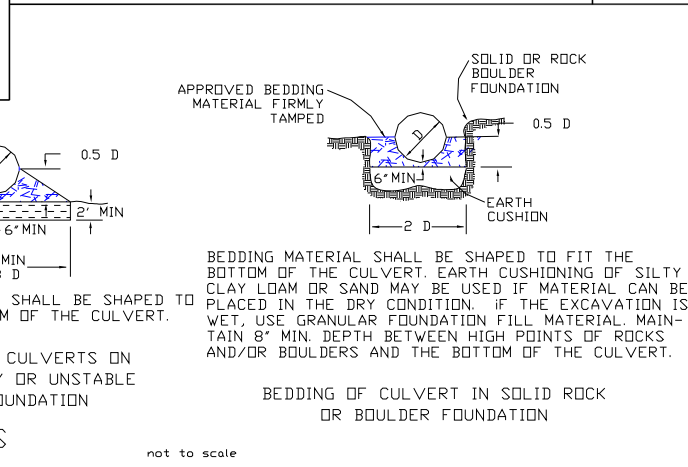
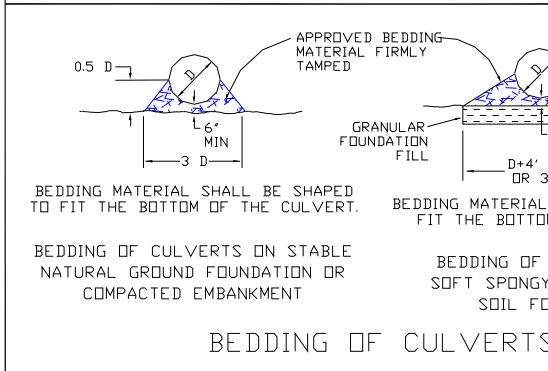
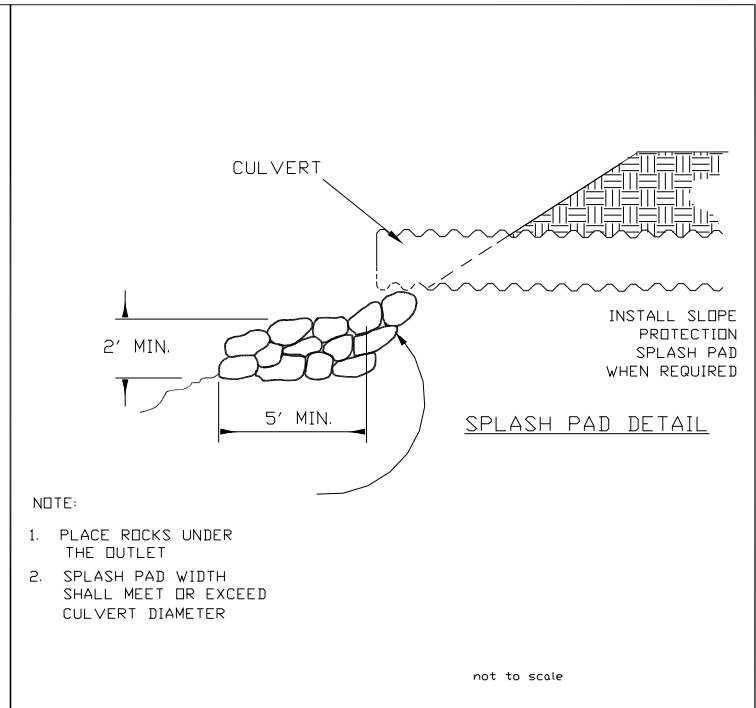
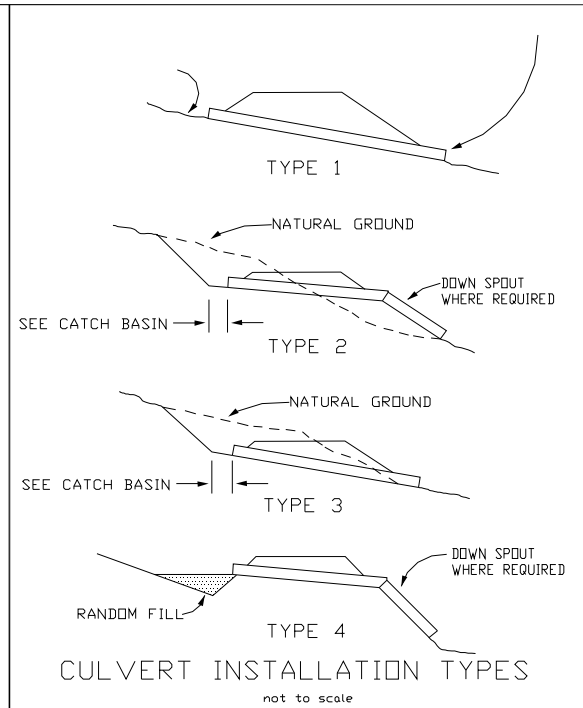
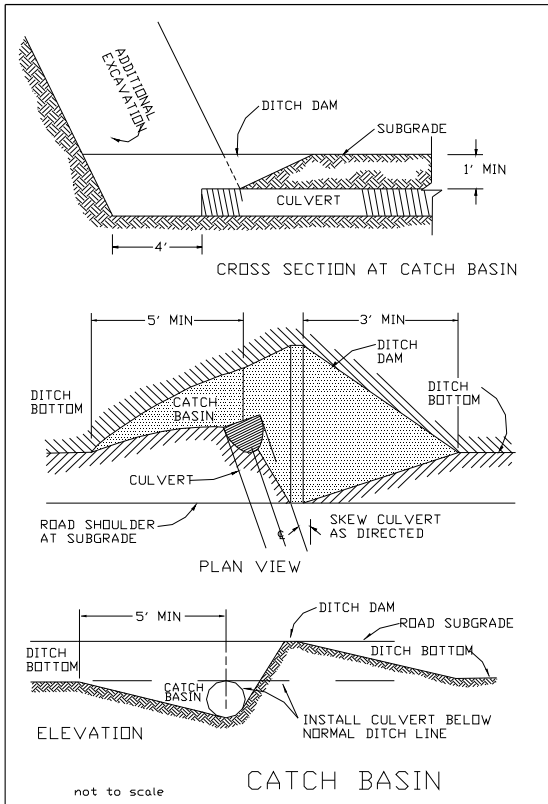



United States Department of the Interior
 BUREAU OF LAND MANAGEMENT
 NORTHWEST OREGON DISTRICT - OREGON
Road Plan Map

Silver Lining Timber Sale
 Contract No. ORN04-TS-2019.0402
 Exhibit C
 Page 40 of 60

7/1/2019

T. 03S. R. 5W Sections 19 & 29 W.M. - NORTHWEST OREGON DISTRICT - OREGON

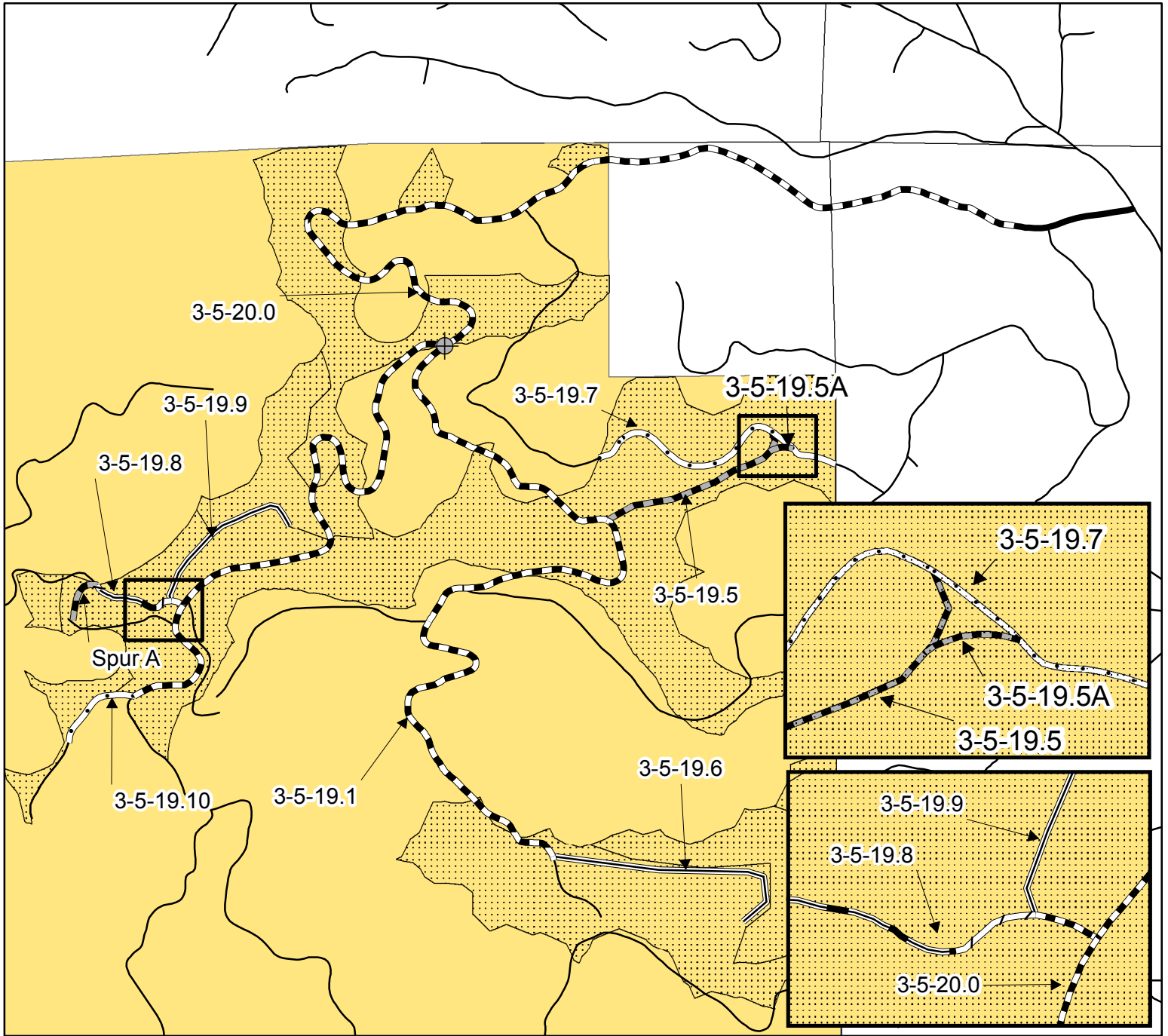

- Improve, Natural surface
- New Construct, Rocked surface, Decommission after use
- New Construct, Natural surface, Decommission after use
- Renovate, Rocked surface
- Renovate, Natural surface, Decommission after use
- Renovate, Natural surface
- Renovate, Paved surface

- Gates
- Other Roads
- Silver Lining Project Area
- Bureau of Land Management

1 inch = 833 feet

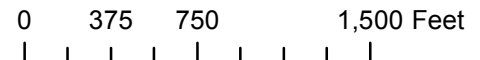

No warranty is made by the Bureau of Land Management as to the accuracy, reliability, or completeness of these data for individual or aggregate use with other data. Original data were compiled from various sources and may be updated without notification. Prepared By: Austin Bettis



United States Department of the Interior
 BUREAU OF LAND MANAGEMENT
 NORTHWEST OREGON DISTRICT - OREGON
Road Plan Map

Silver Lining Timber Sale
 Contract No. ORN04-TS-2019.0402
 Exhibit C
 Page 41 of 60

6/28/2019

T. 03S. R. 5W Sections 19 & 29 W.M. - NORTHWEST OREGON DISTRICT - OREGON

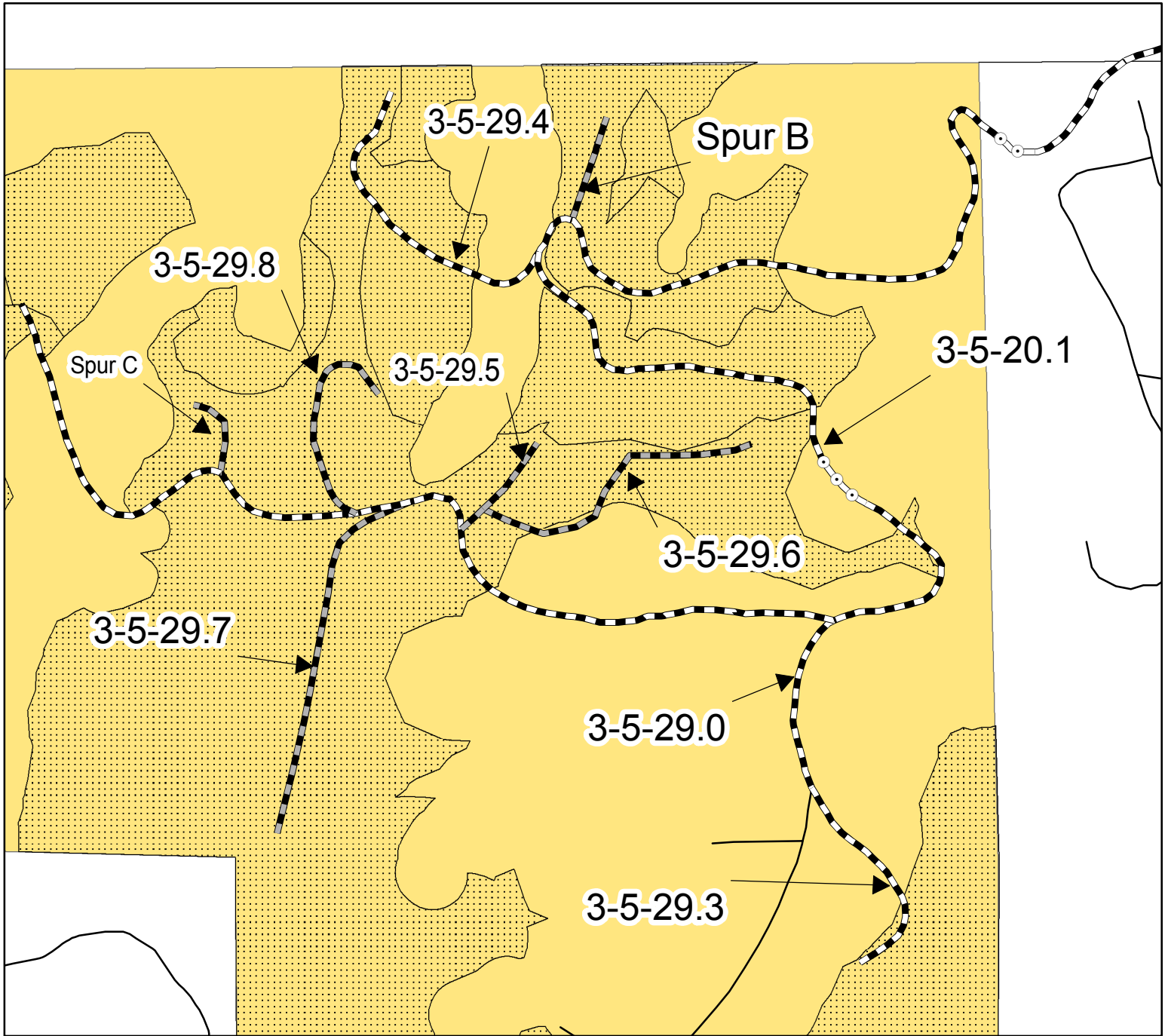

Improve, Rocked surface

New Construct, Natural surface, Decommission after use

Renovate, Rocked surface

Other Roads

Silver Lining Project Area

Bureau of Land Management

1 inch = 500 feet

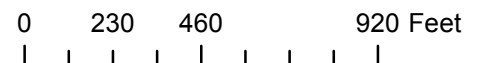

No warranty is made by the Bureau of Land Management as to the accuracy, reliability, or completeness of these data for individual or aggregate use with other data. Original data were compiled from various sources and may be updated without notification. Prepared By: Austin Bettis



United States Department of the Interior
 BUREAU OF LAND MANAGEMENT
 NORTHWEST OREGON DISTRICT - OREGON
Road Plan Map

Silver Lining Timber Sale
 Contract No. ORN04-TS-2019.0402
 Exhibit C
 Page 42 of 60

6/28/2019

T. 03S. R. 5W Sections 19 & 29 W.M. - NORTHWEST OREGON DISTRICT - OREGON

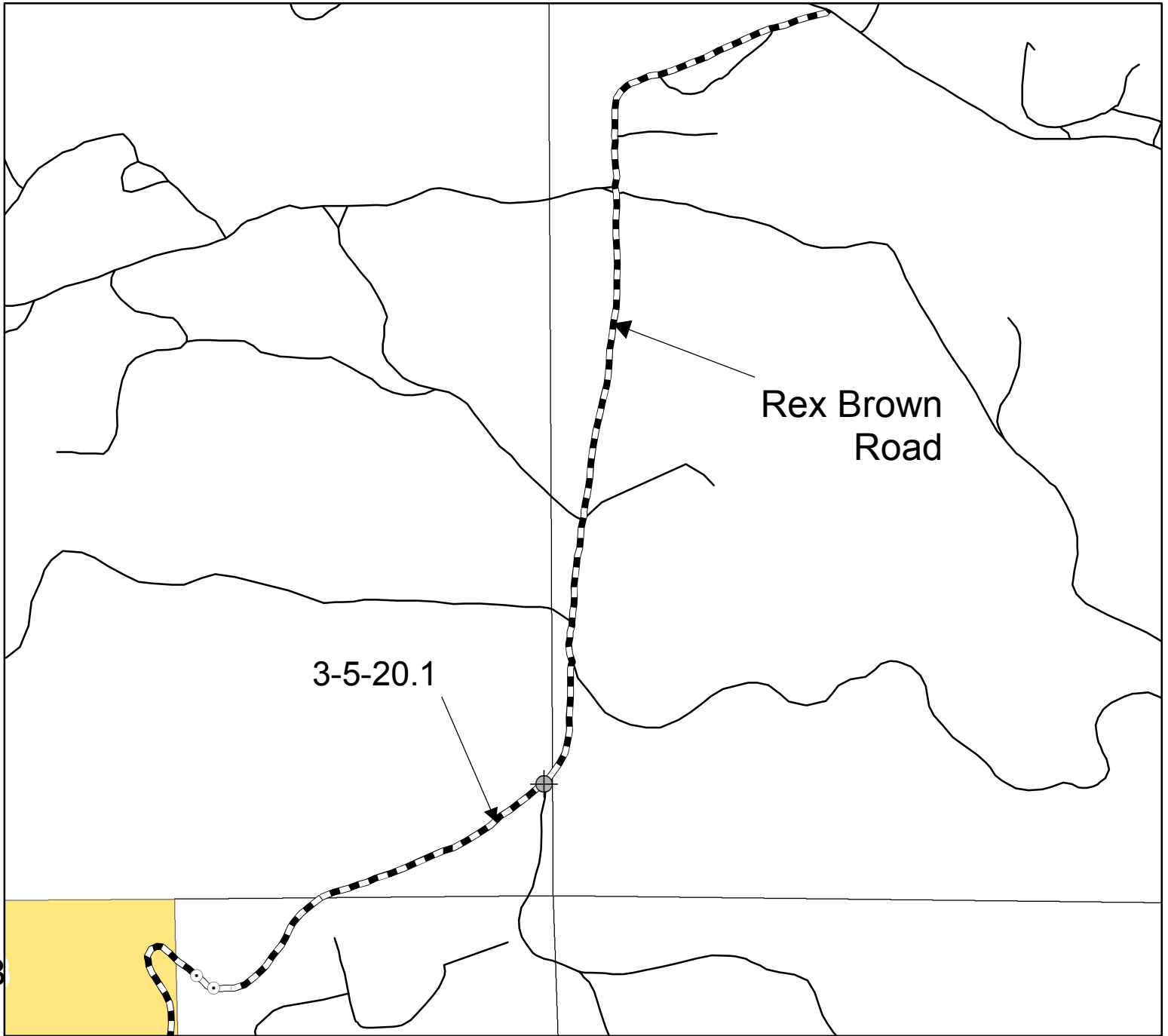

- Improve, Rocked surface
- Renovate, Rocked surface
- Gates
- Other Roads
- Bureau of Land Management

1 inch = 500 feet

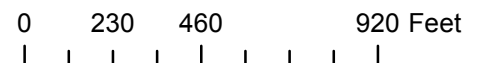

No warranty is made by the Bureau of Land Management as to the accuracy, reliability, or completeness of these data for individual or aggregate use with other data. Original data were compiled from various sources and may be updated without notification. Prepared By: Austin Bettis



United States Department of the Interior
 BUREAU OF LAND MANAGEMENT
 NORTHWEST OREGON DISTRICT - OREGON
Road Plan Map

Silver Lining Timber Sale
 Contract No. ORN04-TS-2019.0402
 Exhibit E
 Page 1 of 3

6/28/2019

T. 03S. R. 5W Sections 19 & 29 W.M. - NORTHWEST OREGON DISTRICT - OREGON

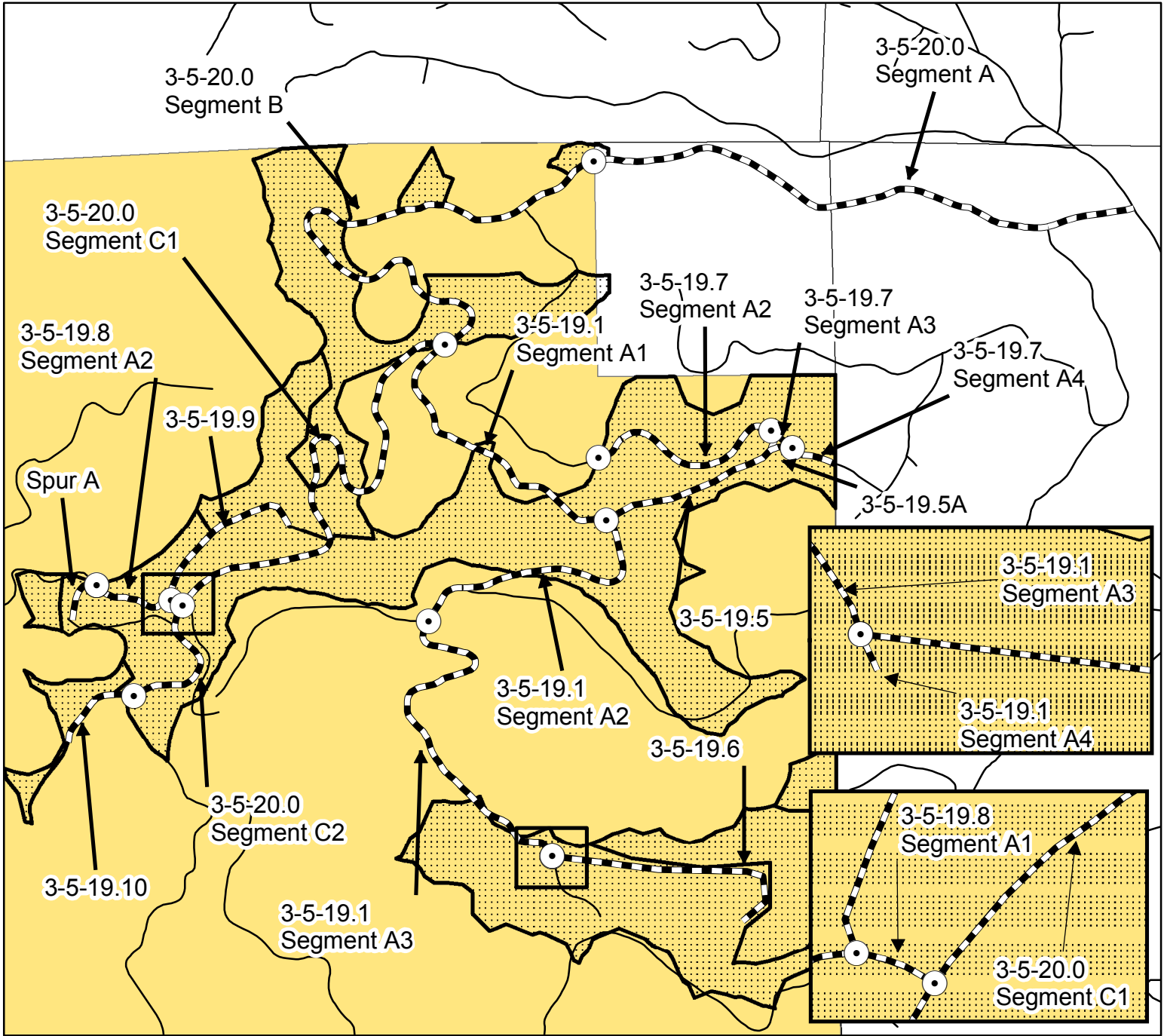

BLM controlled road - Purchaser maintenance

Other Roads

Segment Breaks

Silver Lining Project Area

Bureau of Land Management

1 inch = 833 feet

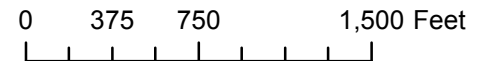

No warranty is made by the Bureau of Land Management as to the accuracy, reliability, or completeness of these data for individual or aggregate use with other data. Original data were compiled from various sources and may be updated without notification. Prepared By: Austin Bettis



United States Department of the Interior
 BUREAU OF LAND MANAGEMENT
 NORTHWEST OREGON DISTRICT - OREGON
Road Plan Map

Silver Lining Timber Sale
 Contract No. ORN04-TS-2019.0402
 Exhibit E
 Page 2 of 3

6/28/2019

T. 03S. R. 5W Sections 19 & 29 W.M. - NORTHWEST OREGON DISTRICT - OREGON

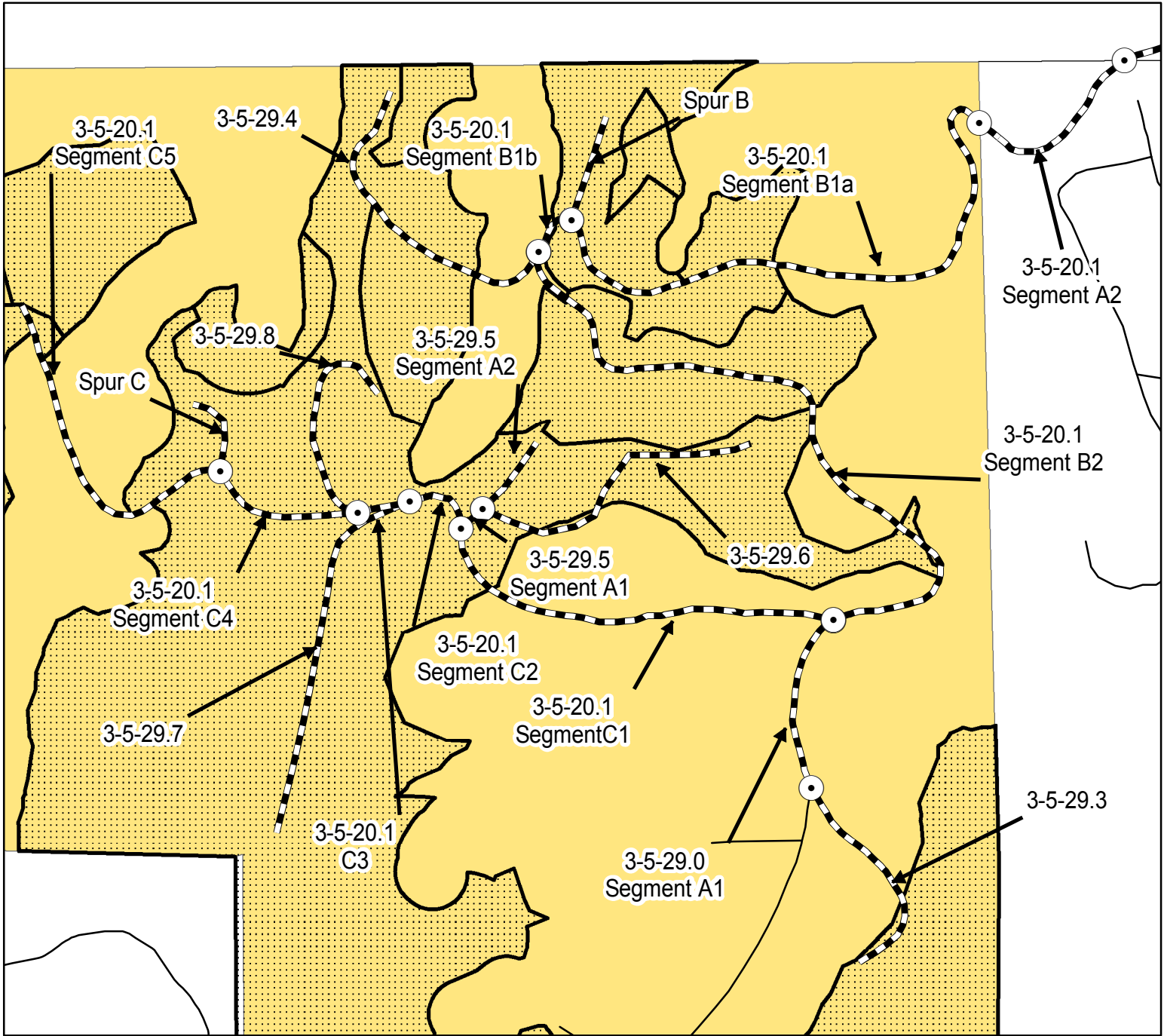

BLM controlled road - Purchaser maintenance

Other Roads

Segment Breaks

Silver Lining Project Area

Bureau of Land Management

1 inch = 500 feet

0 230 460 920 Feet

No warranty is made by the Bureau of Land Management as to the accuracy, reliability, or completeness of these data for individual or aggregate use with other data. Original data were compiled from various sources and may be updated without notification. Prepared By: Austin Bettis







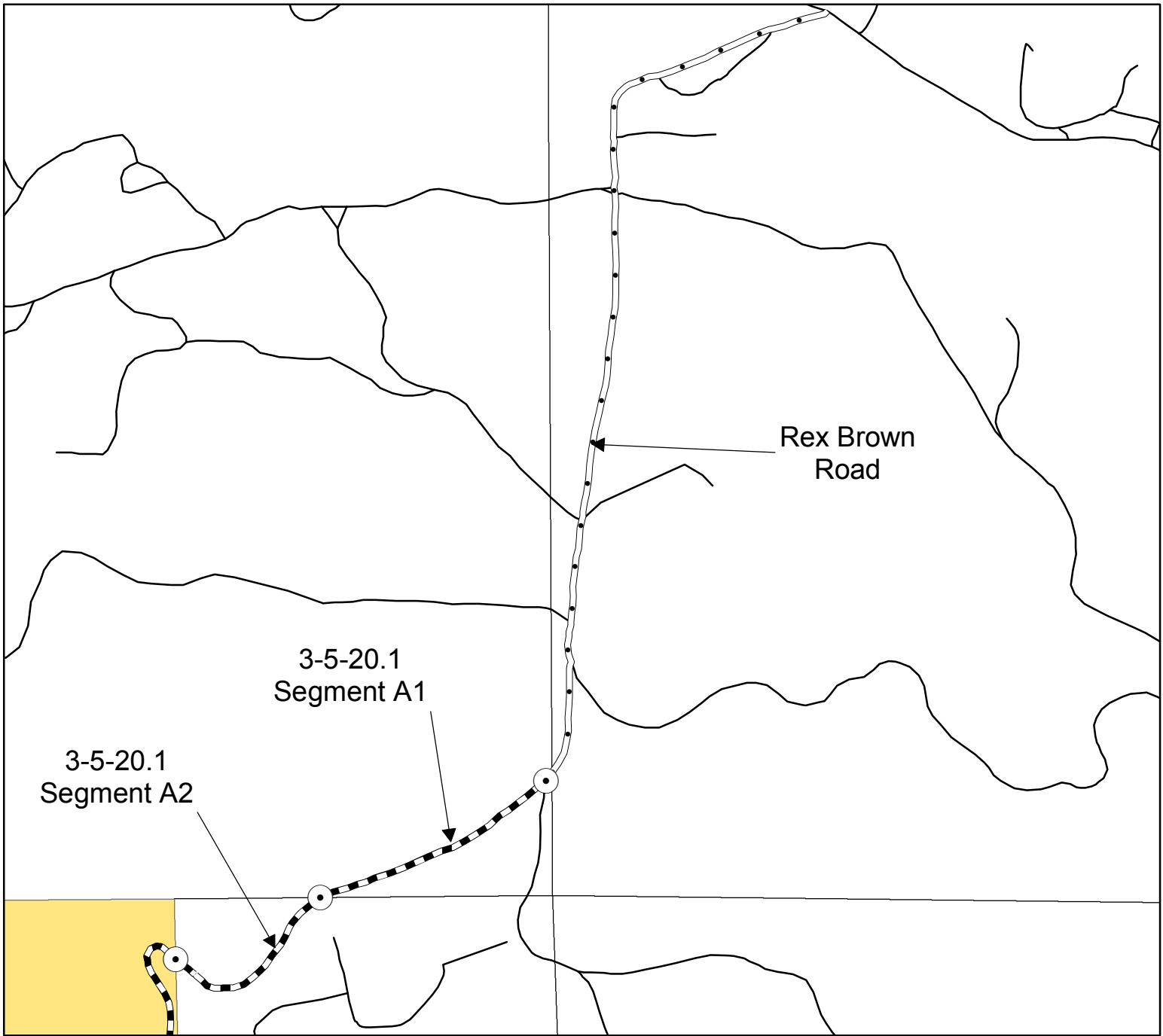

United States Department of the Interior
 BUREAU OF LAND MANAGEMENT
 NORTHWEST OREGON DISTRICT - OREGON
Road Plan Map

Silver Lining Timber Sale
 Contract No. ORN04-TS-2019.0402
 Exhibit E
 Page 3 of 3

6/28/2019

T. 03S. R. 5W Sections 19 & 29 W.M. - NORTHWEST OREGON DISTRICT - OREGON



-  BLM controlled road - Purchaser maintenance
-  County controlled road - County maintenance
-  Other Roads
-  Segment Breaks
-  Bureau of Land Management

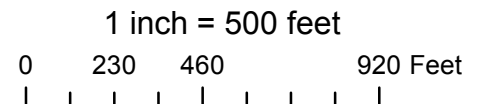

No warranty is made by the Bureau of Land Management as to the accuracy, reliability, or completeness of these data for individual or aggregate use with other data. Original data were compiled from various sources and may be updated without notification. Prepared By: Austin Bettis

EXHIBIT F

**Designation by Prescription (DxP)
 Scale Timber Sale Requirements**

I. Cutting Operations

1. Prior to any cutting operations in the DxP Cutting Areas, the Purchaser shall provide to the Authorized Officer a list of timber fallers and/or mechanical harvester operators who will be conducting the cutting operations.
2. The Purchaser shall notify the Authorized Officer at least forty-eight (48) hours in advance of replacement or addition of a timber faller and/or mechanical harvester operator.
3. Prior to any harvesting operations in a DxP Cutting Area, the Authorized Officer will designate test mark areas. Any timber faller and/or mechanical harvester operator designated to conduct falling operations within a DxP Cutting Area will be required to mark (with paint or flagging) a two (2) acre test mark area to demonstrate their ability to meet the Selection Criteria stated below. The test mark area marking must be approved by the Authorized Officer prior to any falling in the DxP Cutting Area.
4. No yarding of cut timber will be allowed in the DxP Cutting Areas until the cutting operations have been approved by the Authorized Officer.
5. In the event the Purchaser elects to pre-mark (paint) the DxP Cutting Areas prior to falling timber, the Authorized Officer shall approve such marking prior to the start of falling operations.

II. Prescription by Unit

Regeneration Units

Unit Number	Dispersed Reserve trees per acre	Average Spacing of reserve (feet)	Total number of reserve trees
19-1	3.6	110	43
19-2	3	120	265
29-1	2.3	138	14
29-2	2.3	138	14

Thinning Units

Unit Number	Residual trees per acre	Average Spacing of residual trees (feet)
19-3	51	29
19-5	76	24
29-3	40	33
29-4	75	24
29-5	61	27
29-6	68	25
29-7	65	25

Riparian Units

All Riparian Reserve Thinning units have been marked with leave trees. Cut all trees over eight inches that are not marked with orange paint. These include units 19-5 RR, 29-5 RR, 29-6 RR, 29-7 RR.

III. Selection Criteria

1. Reserve Tree Selection Criteria for Thinning Units (19-3, 19-5, 29-3, 29-4, 29-5, 29-6, 29-7)

- Thin from below favoring the largest and healthiest trees to remain. Acceptable residual trees are dominant and co-dominant trees with large live crown (>30% crown ratio), unless noted in the species preference list below.
- All trees forty (40) inches diameter at breast height (dbh) or larger must be reserved regardless of spacing.
- Preference for retained dispersed trees is as follows:
 - Western redcedar over eight (8) inches dbh
 - Bigleaf maple over twelve (12) inches dbh
 - Conifer with significant damage or defect such as cavities, broken tops, forked top, etc.
 - Western hemlock over eight (8) inches dbh
 - Dominant or co-dominant grand fir
 - Dominant or co-dominant Douglas-fir
- Cut all red alder
- Cut all suppressed Douglas-fir and suppressed grand fir with <30% crown ratio
- Leave the four (4) closest trees to any snags over eighteen (18) inches dbh and thirty (30) feet tall.
- **Skips:** These are areas that will not be cut at all. They are mapped and posted as leave islands. Do not cut any trees in skips.
- **Gaps:** Cut all trees within the gap.
- Trees less than eight (8) inches dbh shall not be counted when calculating the residual trees per acre.

2. Reserve Tree Selection Criteria for Regeneration Units (19-1, 19-2, 29-1, 29-2)

- Leave every tree forty (40) inches dbh or larger regardless of spacing.
- In general, leave the largest dominant trees in the unit.
- Preference for retained dispersed trees is as follows:
 - Conifer with significant damage or defect such as cavities, broken tops, forked top, etc.
 - Healthy dominant western redcedar
 - Healthy dominant western hemlock
 - Bigleaf maple > 12 inches dbh
 - Large healthy dominant Douglas-fir (crown ratio > 40%, dbh > 26 inches)
 - Healthy alder (crown ratio > 40%, dbh > 20 inches, few signs of decay)
- Do not mark any intermediate or suppressed trees.

IV. Compliance Inspection

- a. Compliance inspection by the government will consist of visual observation of on-going cutting operations and collecting plot data after the trees have been cut. Non-compliance with the Selection Criteria shall constitute a contract violation which may result in a suspension of operations as provided in Section 10 of the contract. Plot records may include:
1. Diameter and species of both cut trees (stumps) and residual trees to determine contract compliance.
 2. The selection of residual trees (i.e. canopy position, crown ratio and form).
- b. The approval level for the residual trees per acre target for each unit shall be considered met if the average residual trees per acre of all plots measured during one inspection is within following retention specifications. If this requirement falls below the approval level, a written warning will immediately be issued to the Purchaser.
- Commercial thin units: Residual plots should be within 10% of the trees per acre (+/-) target number listed in Section II.
 - Regeneration units: Average spacing of residual trees should be within thirty (30) feet of the target number listed in Section III. The total number of trees reserved should be exact.
- c. If the Purchaser does not comply with the DXP "Selection Criteria" of this Exhibit to the satisfaction of the Authorized Officer after a written warning has been issued, the Authorized Officer may suspend harvest operations until corrective measures, as specified in writing by the Authorized Officer, have been taken by the Purchaser. It will be the responsibility of the Purchaser to pay any costs incurred during the implementation of the corrective measures required by the Authorized Officer. Such corrective measures may include but are not limited to:
1. Replacement of timber faller(s) and/or mechanical harvester operator(s) by the Purchaser.
 2. Approval of timber faller(s) and/or mechanical harvester operator(s) by the Authorized Officer based on the timber faller(s) and/or mechanical harvester operator(s) satisfactory completion of a BLM test plot.
 3. The Purchaser will mark all reserve trees in the Density Management DXP Cutting Areas shown on Exhibit A for approval by the Authorized Officer prior to falling.



United States Department of the Interior
BUREAU OF LAND MANAGEMENT
CUTTING PRESCRIPTION MAP

T03S-R05W Section 19 W. M. - NORTHWEST OREGON DISTRICT - OREGON

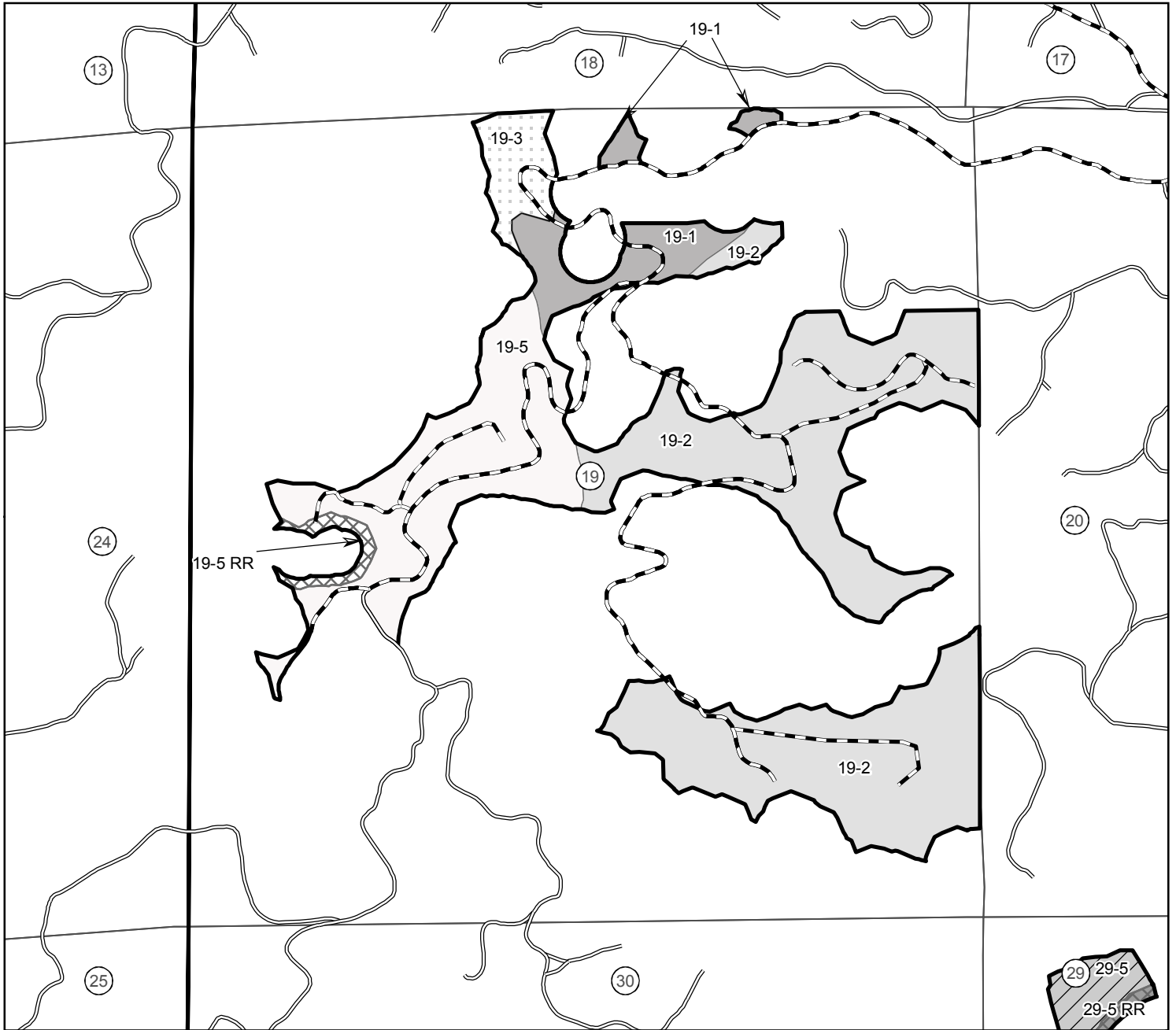

Prescription Units	19-5	Boundary-Cutting Area
19-1	19-5 RR	Project Roads
19-2	29-5	Other Roads
19-3	29-5 RR	

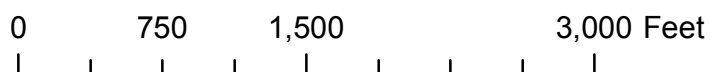



United States Department of the Interior
BUREAU OF LAND MANAGEMENT
CUTTING PRESCRIPTION MAP

T03S-R05W Section 29 W. M. - NORTHWEST OREGON DISTRICT - OREGON

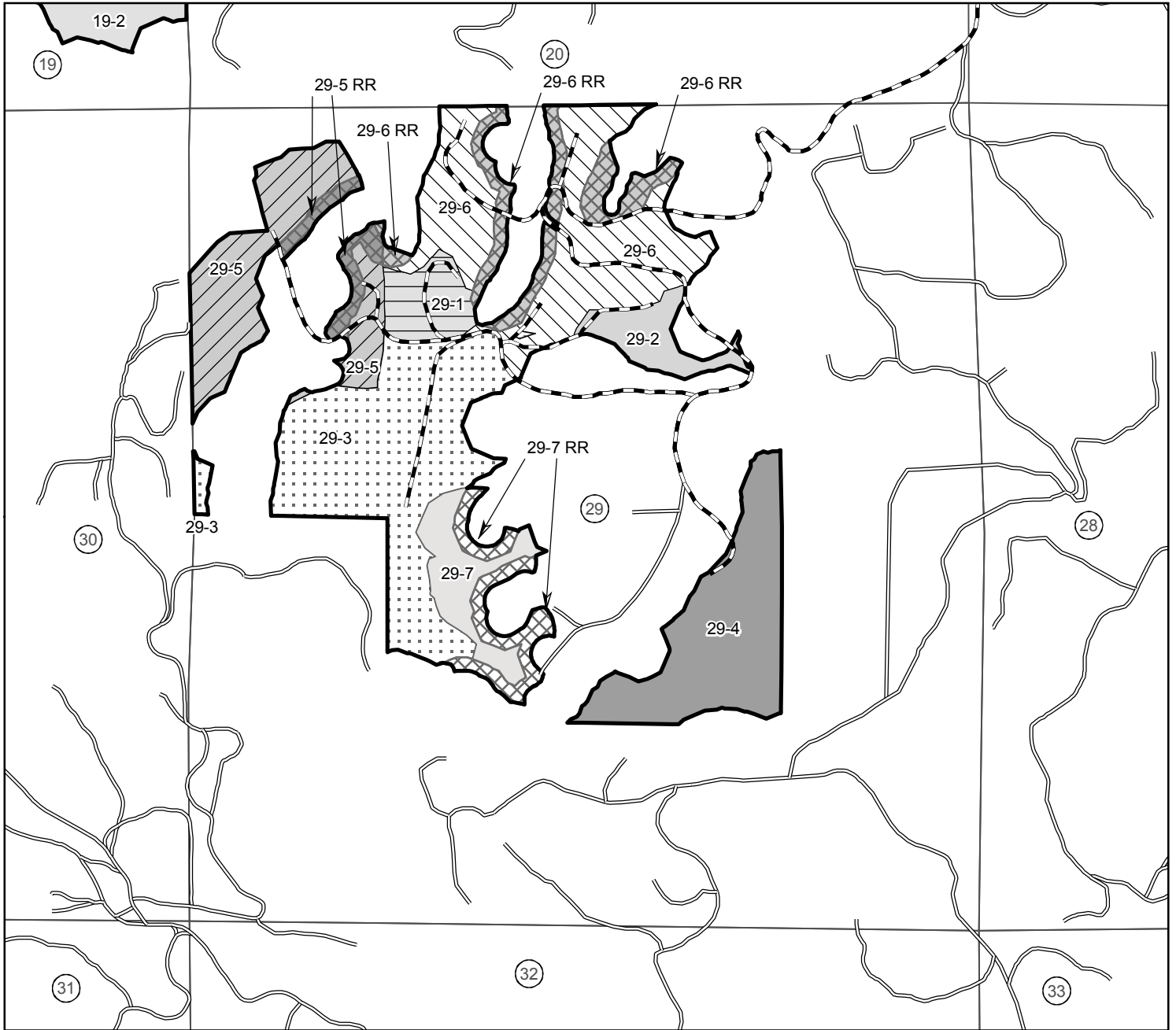

Prescription Units	29-3	29-7	Boundary-Cutting Area
29-1	29-4	29-5 RR	Project Roads
29-2	29-5	29-6 RR	Other Roads
	29-6	29-7 RR	

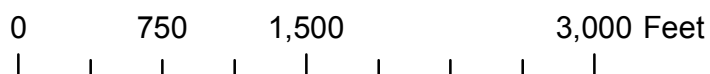

COARSE WOODY DEBRIS (CWD) CREATION

The Purchaser shall select and treat a total of nine hundred eighty-seven (987) reserve trees in the CWD Creation Units shown on Exhibit G to create Coarse Woody Debris (CWD) by saw-topping, high-girdling, basal-girdling or felling. Treated trees will be marked with numbered aluminum tags and flagging. The Purchaser shall record the tree tag number, treatment type, tree data, and UTM coordinates for all treated trees on the Wildlife Tree Data Recording Forms (Illustration #4).

Treatment of trees to create CWD within any given unit shall not start until all yarding operations within that unit are complete. The Purchaser must provide a proposed schedule of work to the Authorized Officer at least one week prior to commencing CWD Creation activities.

CWD Creation per CWD Unit

CWD Unit Number¹ (section)	Acres	Total Trees	Saw-Top	High Girdle	Basal Girdle	Fell	Tree Size to be Selected² (inches at DBH)
1 (19)	105	105	53	52	0	0	20 to 30
2 (19)	42	42	21	21	0	0	20 to 30
19-5RR (19)	6	44	8	8	4	24	fell = 12 to 18 snags = 16 to 24
3 (29)	16	16	8	8	0	0	20 to 30
4 (29)	46	46	23	23	0	0	20 to 30
5 (29)	48	48	24	24	0	0	20 to 30
6 (29)	24	24	12	12	0	0	20 to 30
29-5RR (29)	9	139	35	35	20	49	fell = 12 to 18 snags = 16 to 24
29-6RR (29)	21	296	85	85	40	86	fell = 14 to 20 snags = 16 to 24
29-7RR (29)	17	227	70	70	30	57	fell = 14 to 20 snags = 16 to 24
Totals	334	987	339	338	94	216	

¹ See Coarse Woody Debris Creation maps (Exhibit G pages 10-15)

² Select approximately 50% of the trees larger and 50% of the trees smaller than the median tree size for the given range unless stand conditions dictate otherwise. If only trees smaller than the appropriate size are available, select trees of the largest size class present. Do not select the largest, most dominant tree within any given area.

1. **Tree Selection** – The Purchaser shall select nine hundred eighty-seven (987) reserve trees to create CWD by saw-topping, high-girdling, basal-girdling or felling according to the following guidelines. Unit-specific numbers of trees and sizes are displayed in the table above. Placement of trees to be selected by treatment type within the individual treatment units is displayed on the Coarse Woody Debris Creation maps (Exhibit G pages 10-15).
 - Only Douglas-fir trees shall be selected for treatment.
 - No trees marked with any existing metal tags shall be selected for treatment.
 - No trees with nests or any nest-like structures of any birds or mammals, or trees with defects such as cavities, platforms, mistletoe infection, or dead, forked/multiple and/or broken tops shall be selected.
 - Selected trees shall be evenly distributed throughout the CWD units. When selecting trees, select approximately fifty (50) percent of the trees larger than the median tree size for the given range, and approximately fifty (50) percent of the trees smaller than the median tree size for the given range unless stand conditions dictate otherwise. If only trees smaller than the appropriate size are available, select trees of the largest size class present. Do not select the largest, most dominant tree within any given area.
 - a. **Saw-topping and High-girdling:** Select healthy appearing Douglas-fir trees with live crown ratios greater than thirty (30) percent and with **average or larger** crown spread. If only trees with smaller live crown ratios than appropriate are available, select trees with the largest crown ratio present. Treatment types and selected trees shall be scattered uniformly throughout the units. Trees selected for saw-topping shall be selected singly. Trees selected for high-girdling shall be selected in groups of three (3) to five (5) trees. Trees selected for saw-topping or high-girdling shall not be located within seventy-five (75) feet of a drivable road or a property line boundary where BLM land abuts non-federal ownership.
 - b. **Basal-girdling:** Select Douglas-fir trees with live crown ratios **less** than thirty (30) percent and **smaller** than average crown spread. If only trees with larger live crown ratios than appropriate are available, select appropriately sized trees with the smallest crown ratio present. Selected trees shall be located within the portion of the CWD units designated for basal-girdling and selected in groups of three (3) to five (5) trees. Trees selected for basal-girdling shall not be located within approximately one hundred fifty (150) feet of a drivable road or a property line boundary where BLM land abuts non-federal ownership. Trees selected for basal-girdling shall be those trees which provide minimal amounts or no shade to streams (e.g., north side of stream channel and/or being an area where topography or tree location minimizes the shade afforded to stream by selected tree, such as being located several tree spacings from the stream channel).
 - c. **Tree felling:** Select Douglas-fir trees with live crown ratios **less** than thirty (30) percent and **smaller** than average crown spread. If only trees with larger live crown ratios than appropriate are available, select appropriately sized trees with the smallest crown ratio present. Selected trees shall be located within the portion of the CWD units designated for felling and shall be scattered uniformly throughout the units and selected singly. Trees to be selected for felling shall be located within one hundred (100) feet of the stream channel and selected so that when felled, the portion of the tree in contact with the stream channel would be at least six (6) inches in diameter.

Trees selected for basal-girdling shall be those trees which provide minimal amounts or no shade to streams (e.g., north side of stream channel and/or being an area where topography or tree location minimizes the shade afforded to stream by selected tree, such as being located several tree spacings from the stream channel).

2. CWD Treatments

a. **Saw-Topping**

1. The Purchaser shall climb and top selected trees at a height of **at least** sixty (60) feet above the ground at a point where approximately twenty to fifty (20-50) percent of the live crown remains; saw-topping heights shall be varied equally within this range (See Illustration 1). Topping shall be done with power tools (e.g., chainsaws).
2. The Purchaser shall cut several V-type notches that are a minimum of six (6) cuts into the sawn top surface of the tree, each a minimum of six (6) inches deep.
3. To the extent practicable, the Purchaser shall retain all green limbs and the largest dead limbs on the treated trees during the climbing and topping operations.
4. Tree tops shall be completely severed from the tree and fall completely to the ground inside unit boundaries.
5. Directionally fall tops in order to not damage existing snags and decay class 3 and 4 down wood larger than twenty-four (24) inches in diameter, under-story conifers, any tree containing a suspected nest of a bird or mammal, or any tree with defects such as hollow cavities, multiple tops, or decay, and avoid contact with unburned burn piles and BLM road spurs.
6. The Purchaser shall tie two (2) pieces of flagging of a color approved by the Authorized Officer around the bole of each treated tree, one (1) at a height of approximately twenty to thirty (20-30) feet above the ground and another at four and one-half (4.5) feet above the ground (measured from the uphill side of the tree).
7. A small numbered aluminum tag shall be nailed to the base of the treated tree (uphill side). The tree tag number shall be recorded on the Wildlife Tree Data Recording Form.

b. **High-Girdling** – within live crown

1. The Purchaser shall climb and girdle selected trees within the live crown at a point where approximately twenty to fifty (20-50) percent of the live crown remains below the point of girdling and at a height of **at least** sixty (60) feet above the ground; girdling heights shall be equally varied within this range. Girdling may be done with a hand tool or power tool and will consist of removing all bark and cambium in a ten to twelve (10-12) inch band completely around the main stem of the tree. (See Illustration #3)
2. Tool cuts must not penetrate more than one-half (0.5) inches into the wood of high-girdled trees.
3. Live limbs below the point of high-girdling shall not be removed. To the extent practicable, the Purchaser shall retain the largest dead limbs on the trees during the climbing and high-girdling operations.

4. The Purchaser shall tie three pieces of flagging of a color approved by the Authorized Officer to each high-girdled tree. One flag shall be tied on a branch visible from the ground near the point of girdle, a second flag shall be tied around the bole of the tree at a height of approximately twenty to thirty (20-30) feet above the ground and a third flag at four and one-half (4.5) feet above the ground (measured from the uphill side of the tree). The two highest flags shall extend at least four (4) feet from the knot.
5. A small numbered aluminum tag shall be nailed to the base of the treated tree (uphill side). The tree tag number shall be recorded on the Wildlife Tree Data Recording Form.

c. Basal-Girdling

1. The Purchaser shall basal-girdle selected trees by making three (3) parallel cuts around the bole of the tree between three (3) and four (4) feet above ground level measured on the uphill side of the tree; power tools may be used. Each cut must connect with itself completely around the tree and penetrate through the cambium layer into the wood at least one-half (0.5) inches, but not more than one and one-half (1.5) inches. The distance between the top cut and the bottom cut shall not exceed twelve (12) inches. (See Illustration #2)
2. The Purchaser shall tie a piece of flagging of a color approved by the Authorized Officer around the bole of each treated tree four and one-half (4.5) feet above the ground (measured from the uphill side of the tree).
3. A small numbered aluminum tag shall be nailed to the base of the treated tree (uphill side). The tree tag number shall be recorded on the Wildlife Tree Data Recording Form.

d. Felling

1. The Purchaser shall completely sever selected trees from the stump and fall them completely to the ground.
2. Stumps shall be no more than four and one-half (4.5) feet tall measured on the uphill side.
3. No part of a fallen tree shall rest outside of unit boundaries, or within one hundred fifty (150) feet of any open (unblocked) road as determined by the Authorized Officer.
4. Directionally fall trees toward the nearest mapped stream.
5. Trees shall be felled into active stream channels only during the Oregon Department of Fish and Wildlife's (ODFW's) in-stream work window (July 15 – September 30) unless a waiver is obtained from ODFW by the BLM.
6. Directionally fall trees away from existing snags, decay class three (3) and four (4) down wood larger than twenty-four (24) inches in diameter, under-story conifers, any tree containing a suspected nest of a bird or mammal, or any green tree with defect such as multiple tops, hollow cavities, or decay.
7. A small numbered aluminum tag shall be nailed to the base of the felled tree. The tree tag number shall be recorded on the Wildlife Tree Data Recording Form.

3. **Documentation**

- a. The Purchaser shall provide the location for all saw-topped, high-girdled, basal-girdled or felled trees by documenting the UTM coordinates using a GPS unit with NAD83 datum, zone 10. If acceptable GPS satellite coverage cannot be obtained at a site, the point shall be hand drawn onto a map and submitted to the Authorized Officer with the Wildlife Tree Data Recording Forms.
- b. The Purchaser shall provide the Wildlife Tree Data Recording Forms, UTM coordinates, and any hand drawn maps in a digital format once per week to the Authorized Officer for work completed during the previous week.
- c. All information recorded on the Wildlife Tree Data Recording Forms shall be legible, clear and reproducible on a black and white copy machine. All documents shall be reviewed by the Purchaser to ensure completeness, legibility, accuracy, and consistency in style before submitting them to the Authorized Officer.

ILLUSTRATION #1 – Saw-topping within the Live Crown

Cut a V-type notch or a “King’s Crown” (with a minimum of 6 cuts) into the sawn top surface, a minimum of 6 inches deep, to provide for a greater potential of future decay in the treetop. To the extent practicable, retain all green limbs and the largest dead limbs on the treated trees during the climbing and topping operation.

The tree shall be topped at a height of at least 60 feet above the ground at a point where approximately 20% to 50% of the live crown remains.

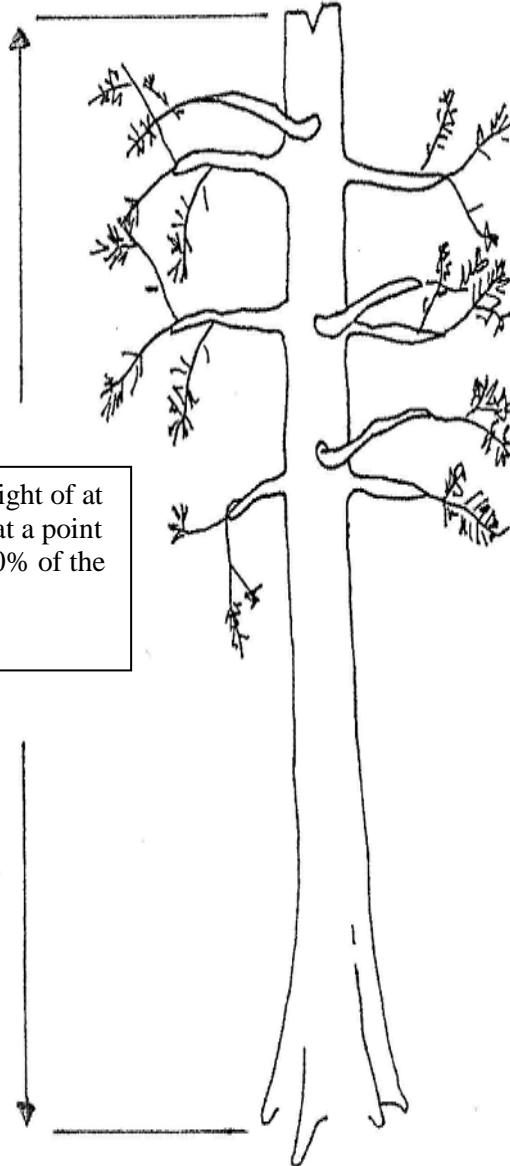

Tie two pieces of flagging around the bole of each saw-topped tree, one at a height of approximately 20-30 feet and one 4.5 feet above the ground. A small numbered aluminum tag is nailed to the base of the tree (uphill side).

Basal-Girdling ILLUSTRATION #2

Girdling example: make three (3) parallel unbroken cuts around the tree. The distance between the top and the bottom of the cut shall not exceed twelve inches. Cuts must penetrate at least $\frac{1}{2}$ inch, but not more than $1\frac{1}{2}$ inches into the wood of the tree. Trees shall be girdled between 3 and 4 feet from the ground.

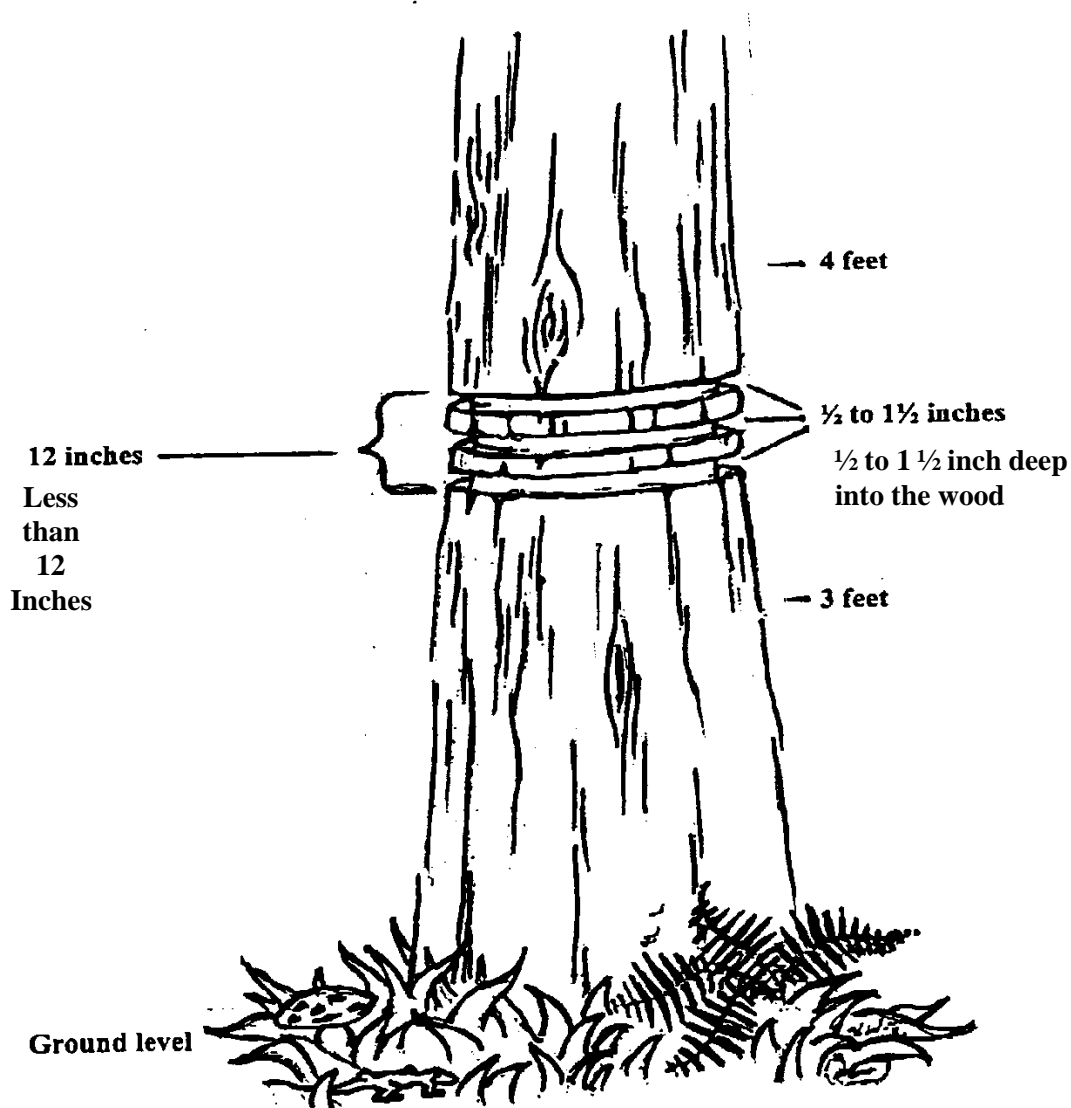

Tie one piece of flagging around the bole of each basal-girdled tree 4.5 feet above the ground. A small numbered aluminum tag is nailed to the base of the tree (up-hill side).

Illustration #3 – High-Girdling within the Live Crown

Crown Girdling Specifications:

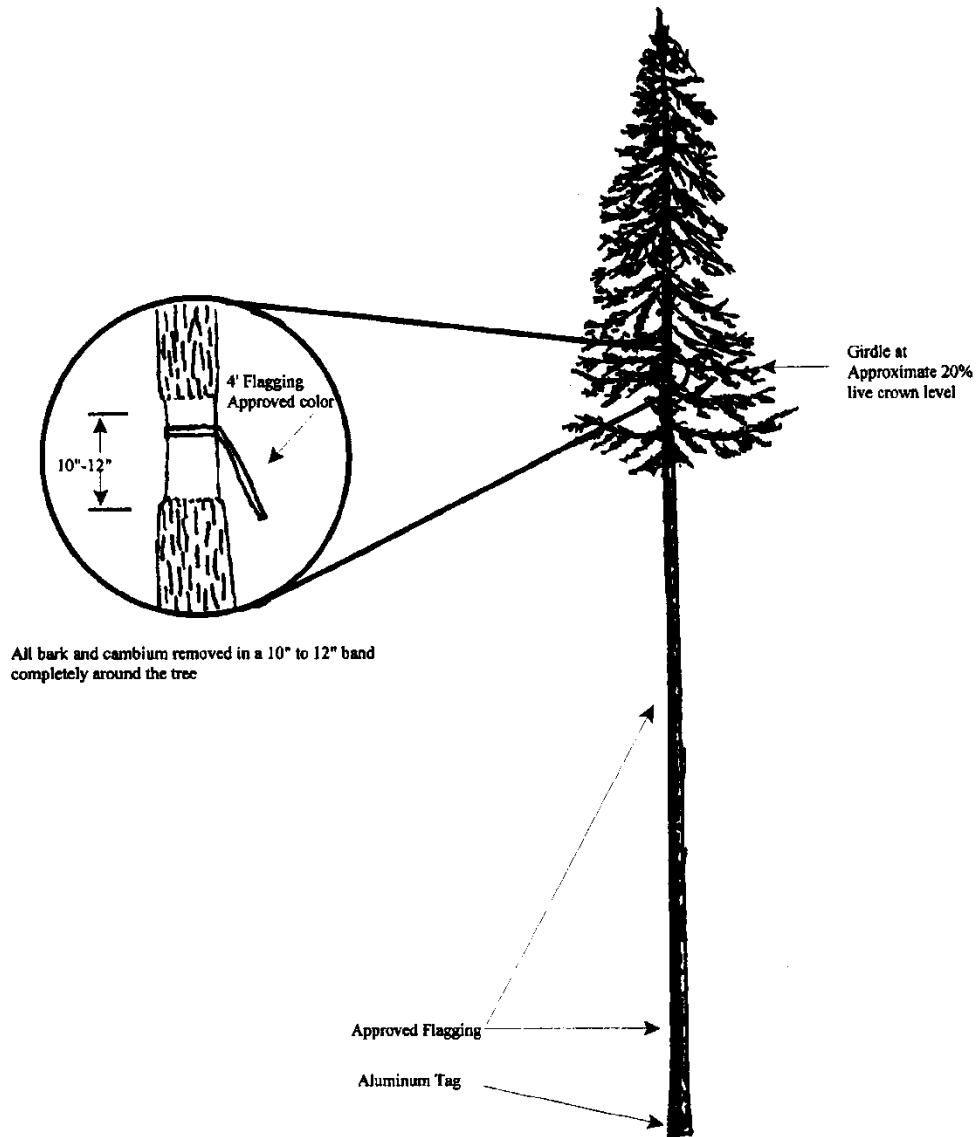

To the extent practicable, retain all green limbs and the largest dead limbs on the treated trees below the point of treatment. Treatment heights shall be greater than or equal to 60 feet above the ground at a point in the live crown where 20% to 50% of live branches remain. Tie three pieces of flagging around the bole of each high-girdled tree, one at the point of girdling, one at a height of approximately 20-30 feet and one 4.5 feet above the ground.

A small numbered aluminum tag is nailed to the base of the tree (uphill side).

ILLUSTRATION #4 Wildlife Tree Data Recording Form Date _____ Page _____

UNIT # _____ **Name(s)** _____

Tree Tag #	Treatment Type ¹	DBH ²	UTM ³ (E)	UTM ³ (N)	Treatment Diameter	Initials	Remarks

¹ **Treatment Types:** ST = Saw-top; HG = High-Girdle; BG = Basal-Girdle; F = Fell.
² **DBH** = Diameter of treated tree measured at 4.5 feet above the ground on the uphill side to the nearest one (1) inch.
³ **UTM** = Universal Transverse Mercator *Coordinates (GPS) in NAD 83 datum*



United States Department of the Interior
 BUREAU OF LAND MANAGEMENT
Coarse Woody Debris Creation

Silver Lining Timber Sale
 ORN04-TS-2019.0402
 Exhibit G
 Page 10 of 15

T03S-R05W Section 19 W. M. - NORTHWEST OREGON DISTRICT - OREGON

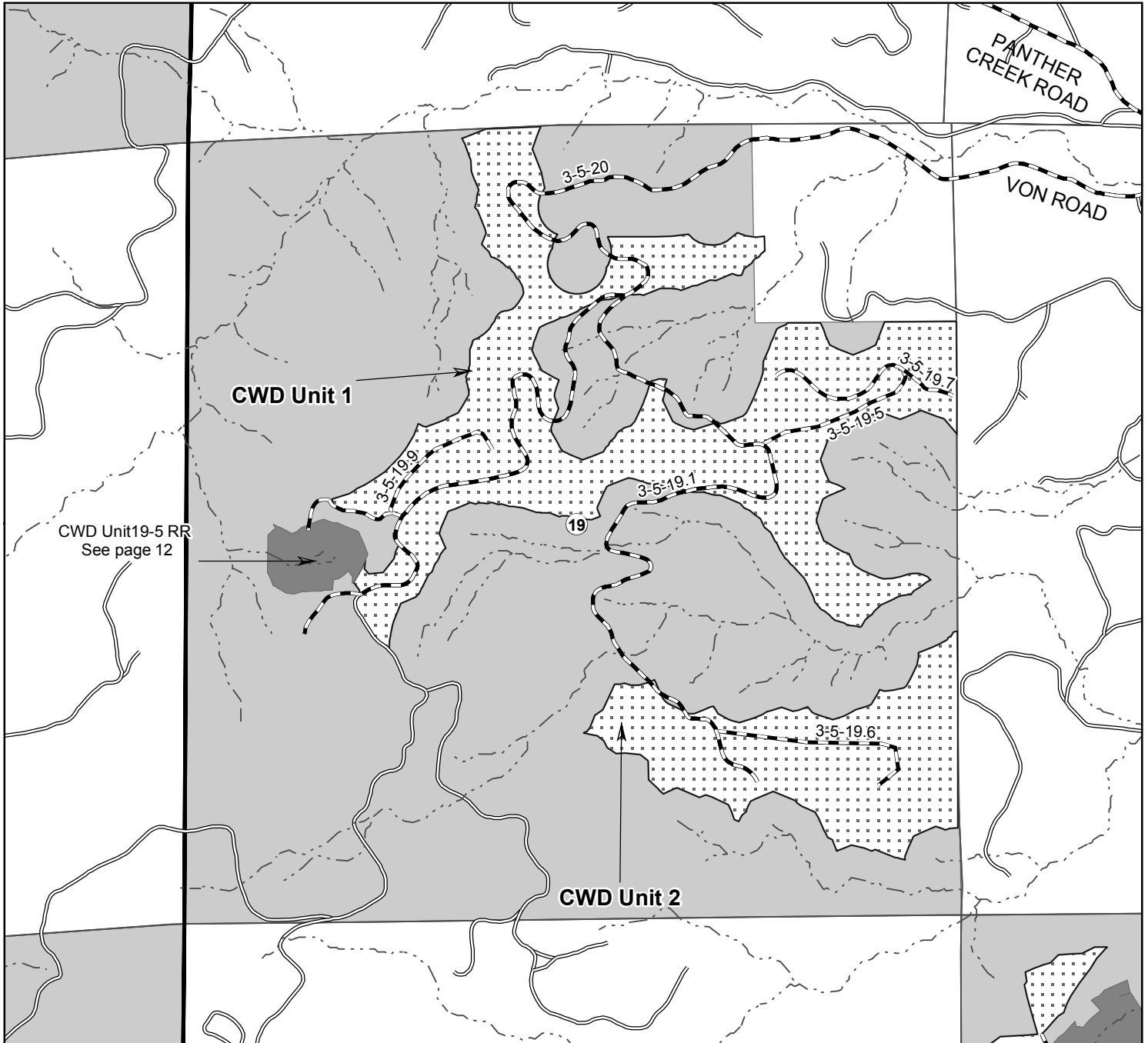







-  Saw Top and High Girdle
-  Silver Lining Riparian Reserve Treatment Areas
-  Silver Lining Project Roads
-  Streams
-  Other Roads
-  BLM Land

Exhibit G CWD Unit	Acres	Total Trees	Saw-Top	High Girdle	Basal Girdle	Fell	Tree Size to be Selected * (Inches DBH)
1	105	105	53	52	0	0	20 to 30
2	42	42	21	21	0	0	20 to 30



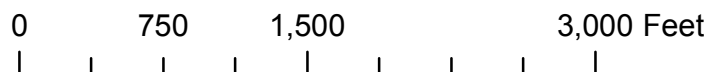

United States Department of the Interior
 BUREAU OF LAND MANAGEMENT
Coarse Woody Debris Creation

T03S-R05W Section 29 W. M. - NORTHWEST OREGON DISTRICT - OREGON

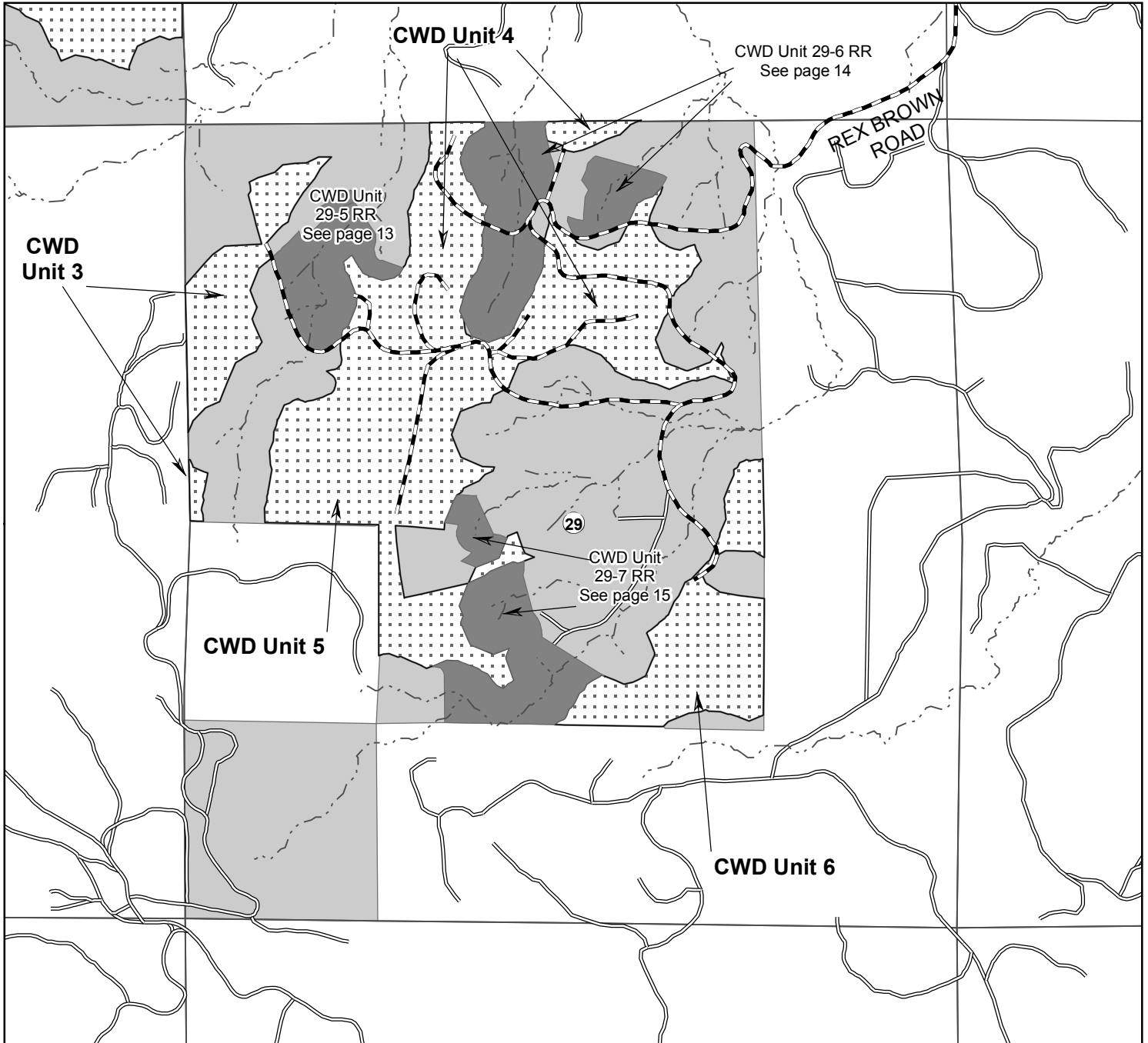

- Saw Top and High Girdle
- Silver Lining Riparian Reserve Treatment Areas
- Silver Lining Project Roads
- Streams
- Other Roads
- BLM Land

Exhibit G CWD Unit	Acres	Total Trees	Saw-Top	High Girdle	Basal Girdle	Fell	Tree Size to be Selected * (Inches DBH)
3	16	16	8	8	0	0	20 to 30
4	46	46	23	23	0	0	20 to 30
5	48	48	24	24	0	0	20 to 30
6	24	24	12	12	0	0	20 to 30

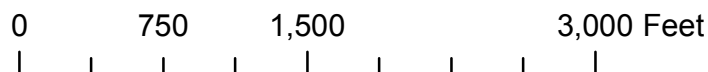



United States Department of the Interior
 BUREAU OF LAND MANAGEMENT
Coarse Woody Debris Creation

Silver Lining Timber Sale
 ORN04-TS-2019.0402
 Exhibit G
 Page 12 of 15

T03S-R05W Section 19 W. M. - NORTHWEST OREGON DISTRICT - OREGON



-  Saw Top and High Girdle
-  Basal Girdle, Saw Top and High Girdle
-  Felling, Basal Girdle, Saw Top and High Girdle
-  Silver Lining Upland Treatment Area
-  Silver Lining Project Roads
-  Streams
-  Other Roads
-  BLM Land

Exhibit G CWD Unit	Acres	Total Trees	Saw-Top	High Girdle	Basal Girdle	Fell	Tree Size to be Selected * (Inches DBH)
19-5 RR	6	44	8	8	4	24	Fell=12 to 18 Snags=16 to 24



No warranty is made by the Bureau of Land Management as to the accuracy, reliability, or completeness of these data for individual or aggregate use with other data. Original data were compiled from various sources and may be updated without notification.

Prepared By: csween Date: 6/28/2019

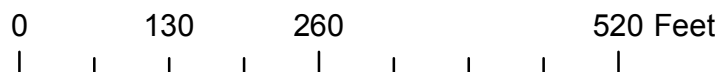

United States Department of the Interior
 BUREAU OF LAND MANAGEMENT
Coarse Woody Debris Creation

Silver Lining Timber Sale
 ORN04-TS-2019.0402
 Exhibit G
 Page 13 of 15

T03S-R05W Section 29 W. M. - NORTHWEST OREGON DISTRICT - OREGON

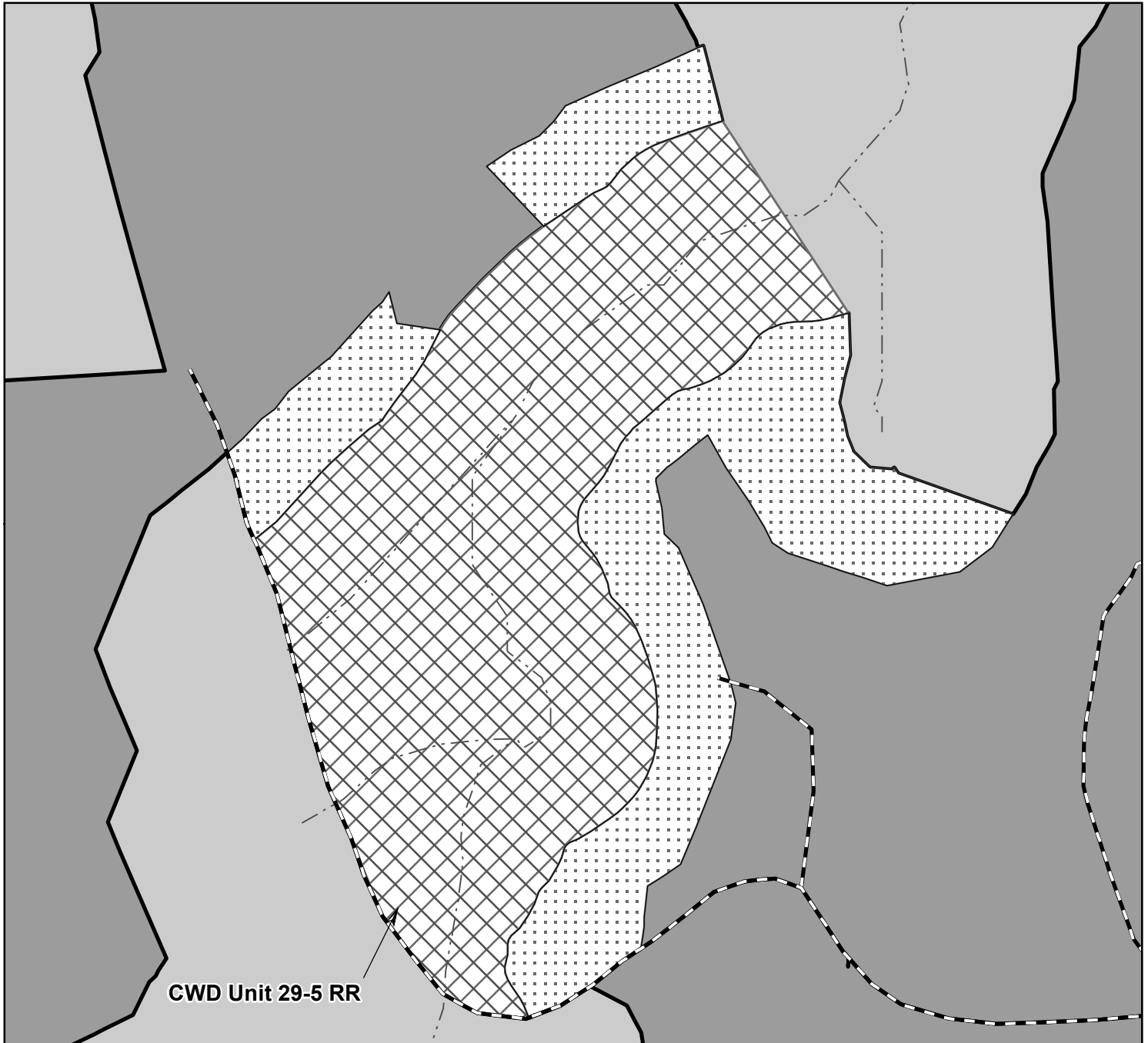



-  Saw Top and High Girdle
-  Felling, Basal Girdle, Saw Top and High Girdle
-  Silver Lining Upland Treatment Area
-  Silver Lining Project Roads
-  Streams
-  Other Roads
-  BLM Land

Exhibit G CWD Unit	Acres	Total Trees	Saw-Top	High Girdle	Basal Girdle	Fell	Tree Size to be Selected * (Inches DBH)
29-5 RR	9	139	35	35	20	49	Fell=12 to 18 Snags=16 to 24



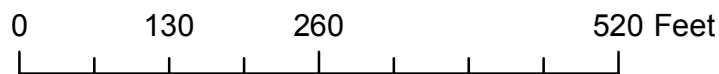

United States Department of the Interior
 BUREAU OF LAND MANAGEMENT
Coarse Woody Debris Creation

Silver Lining Timber Sale
 ORN04-TS-2019.0402
 Exhibit G
 Page 14 of 15

T03S-R05W Section 29 W. M. - NORTHWEST OREGON DISTRICT - OREGON

CWD Unit 29-6 RR

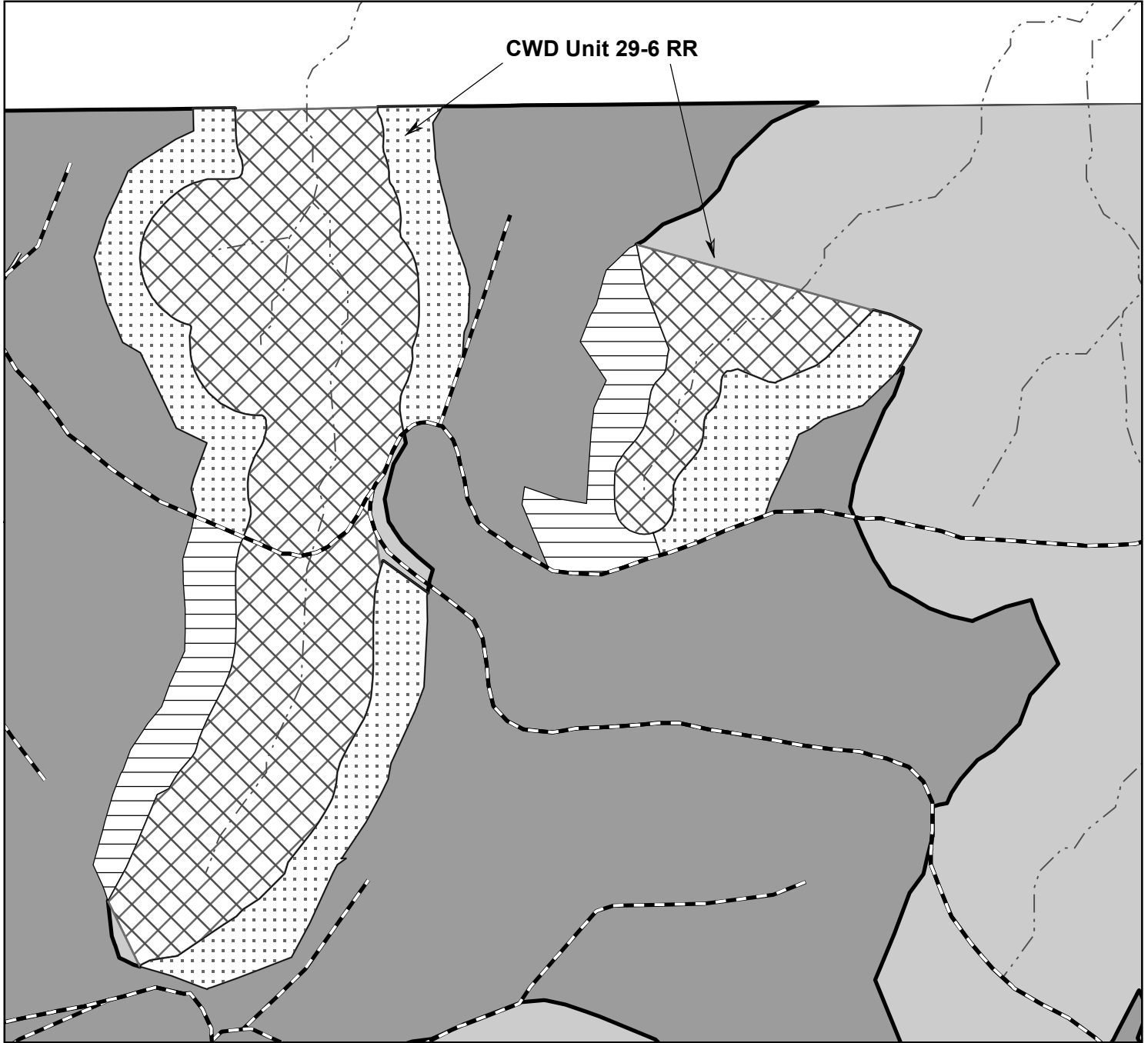





-  Saw Top and High Girdle
-  Basal Girdle, Saw Top and High Girdle
-  Felling, Basal Girdle, Saw Top and High Girdle
-  Silver Lining Upland Treatment Area
-  Silver Lining Project Roads
-  Streams
-  Other Roads
-  BLM Land

Exhibit G CWD Unit	Acres	Total Trees	Saw-Top	High Girdle	Basal Girdle	Fell	Tree Size to be Selected * (Inches DBH)
29-6 RR	21	296	85	85	40	86	Fell=14 to 20 Snags=16 to 24



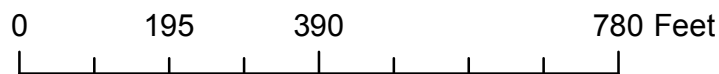

United States Department of the Interior
 BUREAU OF LAND MANAGEMENT
Coarse Woody Debris Creation

Silver Lining Timber Sale
 ORN04-TS-2019.0402
 Exhibit G
 Page 15 of 15

T03S-R05W Section 29 W. M. - NORTHWEST OREGON DISTRICT - OREGON

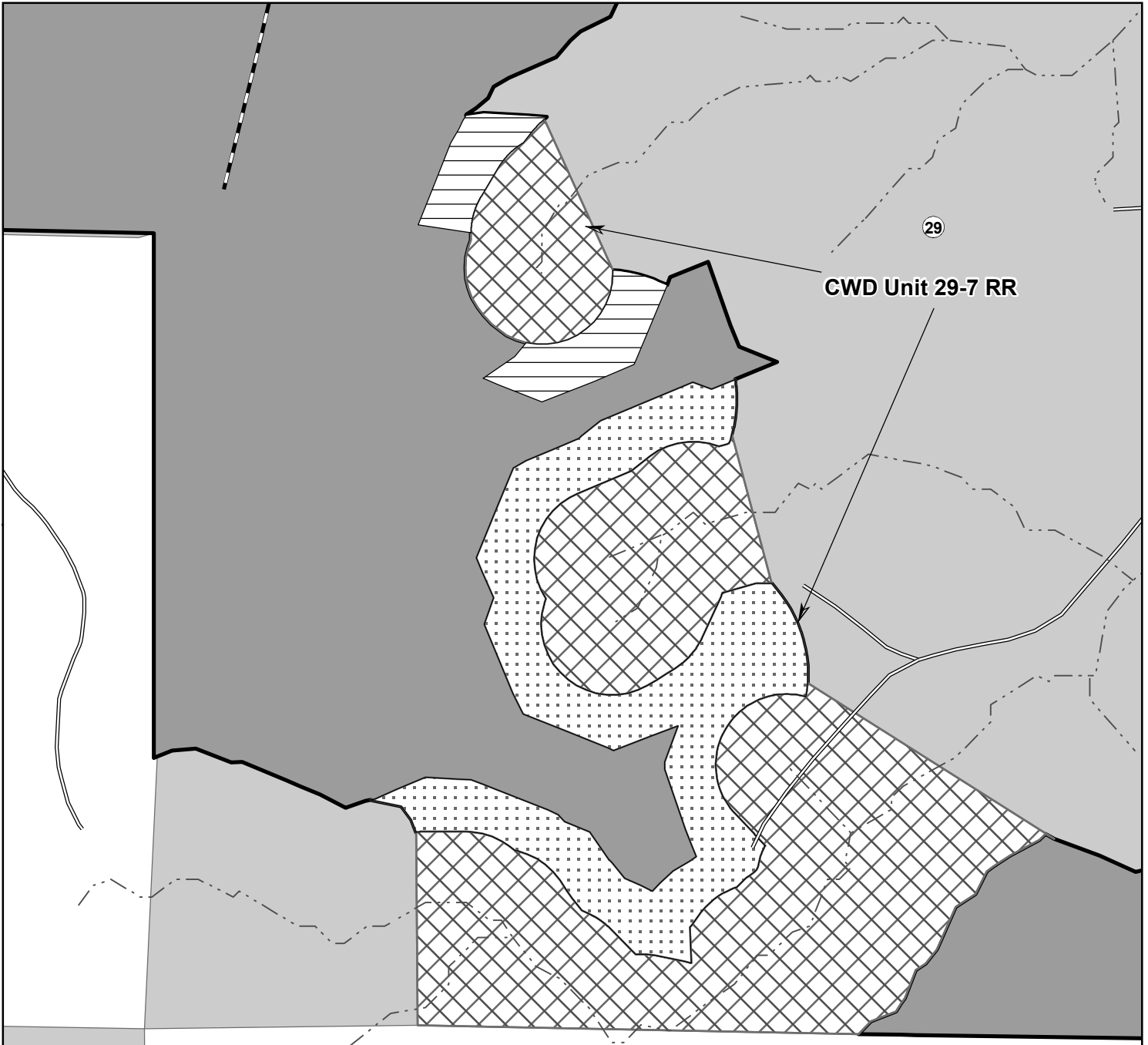

-  Saw Top and High Girdle
-  Basal Girdle, Saw Top and High Girdle
-  Felling, Basal Girdle, Saw Top and High Girdle
-  Silver Lining Upland Treatment Area
-  Silver Lining Project Roads
-  Streams
-  Other Roads
-  BLM Land

Exhibit G CWD Unit	Acres	Total Trees	Saw-Top	High Girdle	Basal Girdle	Fell	Tree Size to be Selected * (Inches DBH)
29-7 RR	17	227	70	70	30	57	Fell=14 to 20 Snags=16 to 24

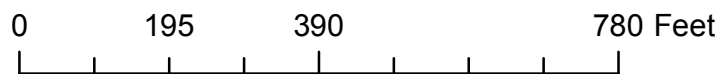

United States Department of the Interior
 BUREAU OF LAND MANAGEMENT
PROJECT LOCATION MAP

Silver Lining Timber Sale
 Contract No. ORN04-TS-2019.0402
 Project Location Map
 Page 1 of 1



T. 3S. R. 5W. Sections 19 & 29 W. M. - NORTHWEST OREGON DISTRICT - OREGON

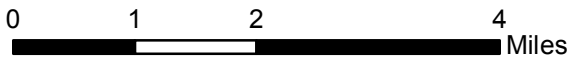
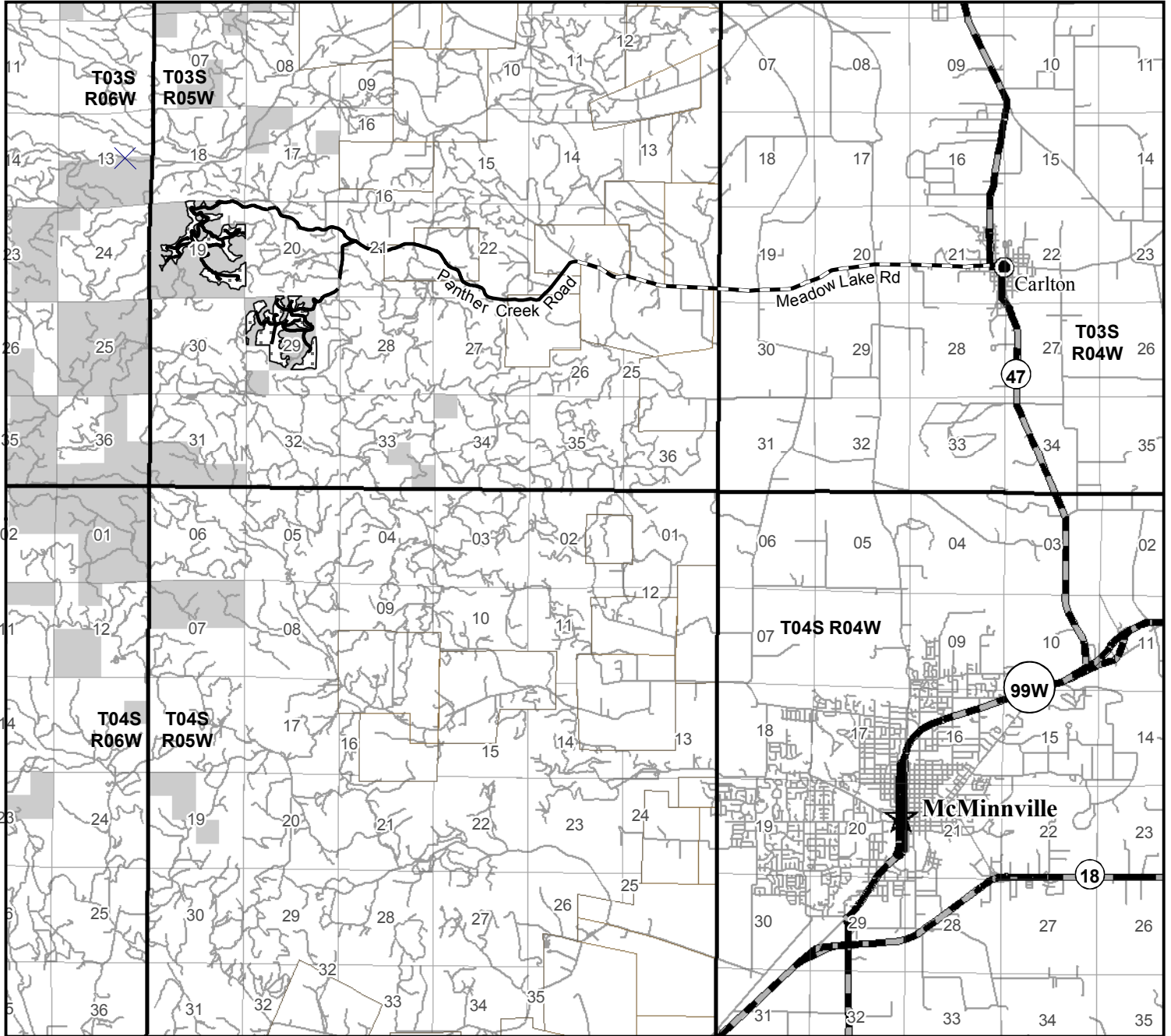

- Silver Lining Project Area
- Highway
- Silver Lining Project Roads
- Other Roads
- Meadow Lake Road
- Bureau of Land Management









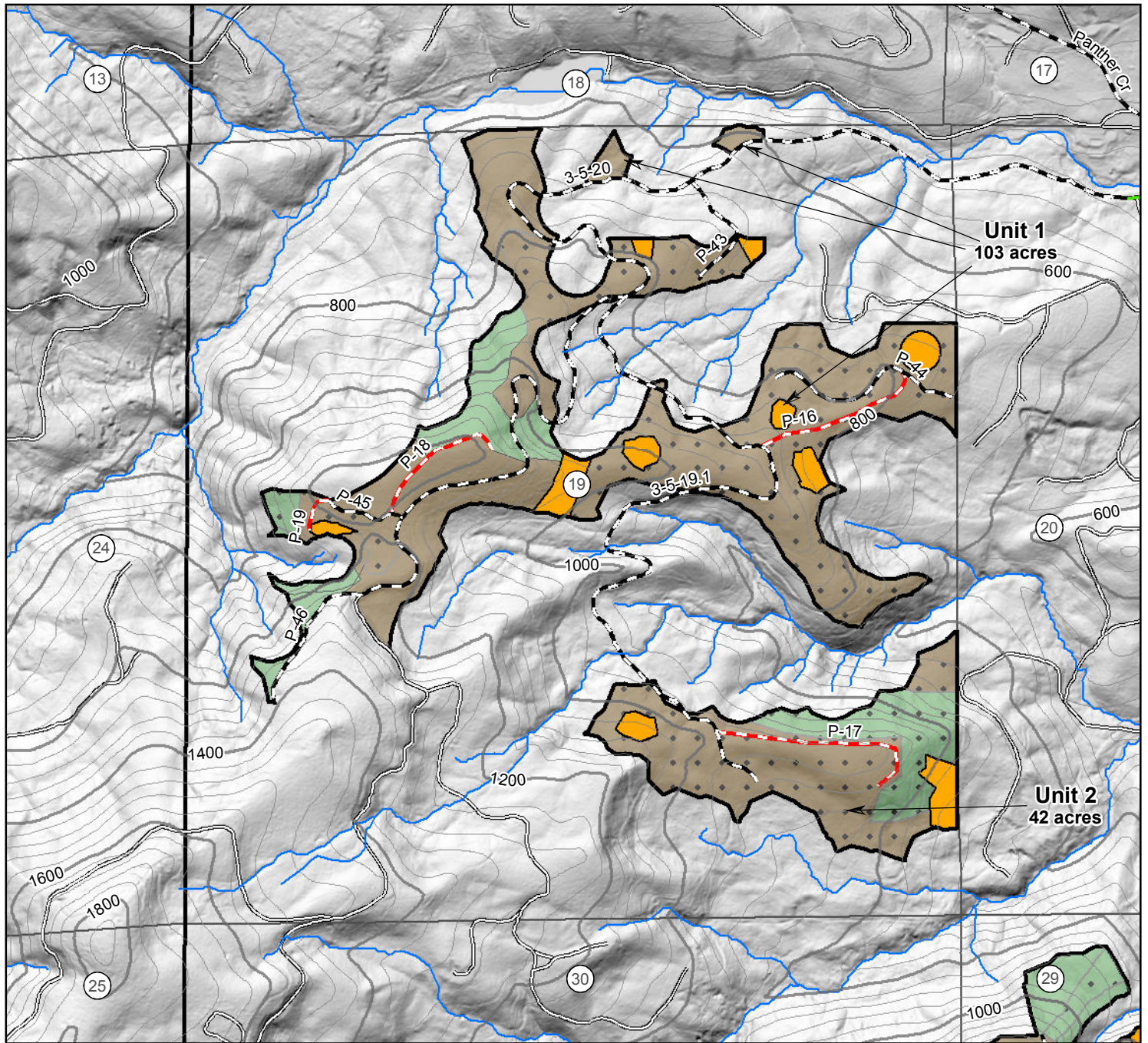

No warranty is made by the Bureau of Land Management as to the accuracy, reliability, or completeness of these data for individual or aggregate use with other data. Original data were compiled from various sources and may be updated without notification.
 Prepared By: csween 7/12/2019

United States Department of the Interior
BUREAU OF LAND MANAGEMENT

T03S-R05W Section 19 W. M. - NORTHWEST OREGON DISTRICT - OREGON



Contour Interval: 40ft

- | | |
|---|--|
|  Partial Cut Area-Ground Based |  Road to be constructed |
|  Regeneration Cut Area-Ground Based |  Road to be renovated |
|  Partial Cut Area-Skyline |  Road to be improved |
|  Regeneration Cut Area-Skyline |  Other Roads |
| |  Streams |

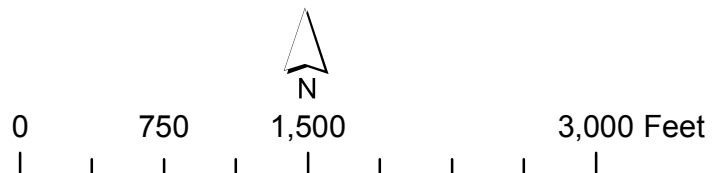







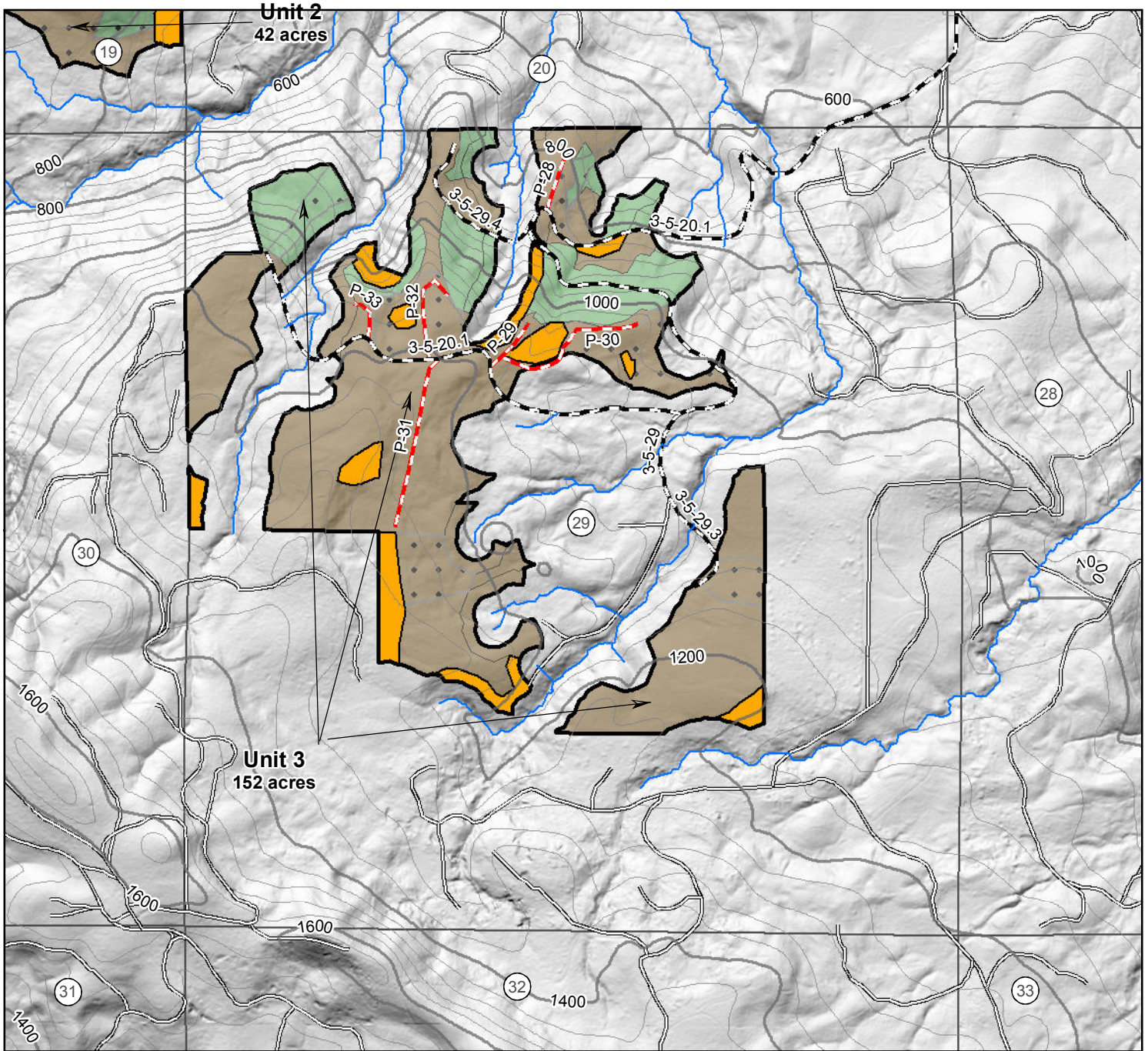

No warranty is made by the Bureau of Land Management as to the accuracy, reliability, or completeness of these data for individual or aggregate use with other data. Original data were compiled from various sources and may be updated without notification. Note: Boundaries of harvest area and rights-of-ways (ROW) are painted orange and posted. Harvest area acres do not include existing roads. Acres shown on Exhibit A for harvest area have been computed using a S1 mobile mapper and Trimble R1 GNSS Receiver. Prepared By: csween Date: 6/14/2019

United States Department of the Interior
 BUREAU OF LAND MANAGEMENT

T03S-R05W Section 29 W. M. - NORTHWEST OREGON DISTRICT - OREGON



Contour Interval: 40ft

- | | | | |
|--|------------------------------------|---|------------------------|
|  | Partial Cut Area-Ground Based |  | Road to be constructed |
|  | Regeneration Cut Area-Ground Based |  | Road to be renovated |
|  | Partial Cut Area-Skyline |  | Other Roads |
|  | Regeneration Cut Area-Skyline |  | Streams |

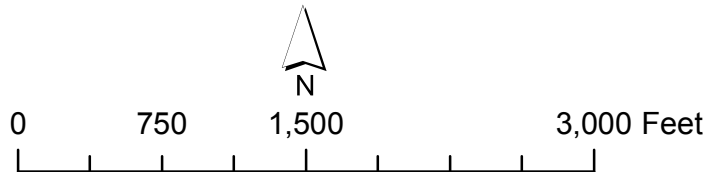

No warranty is made by the Bureau of Land Management as to the accuracy, reliability, or completeness of these data for individual or aggregate use with other data. Original data were compiled from various sources and may be updated without notification. Note: Boundaries of harvest area and rights-of-ways (ROW) are painted orange and posted. Harvest area acres do not include existing roads. Acres shown on Exhibit A for harvest area have been computed using a S1 mobile mapper and Trimble R1 GNSS Receiver.
 Prepared By: csween Date: 6/14/2019

Silver Lining 3S-5W-19 Logging Plan

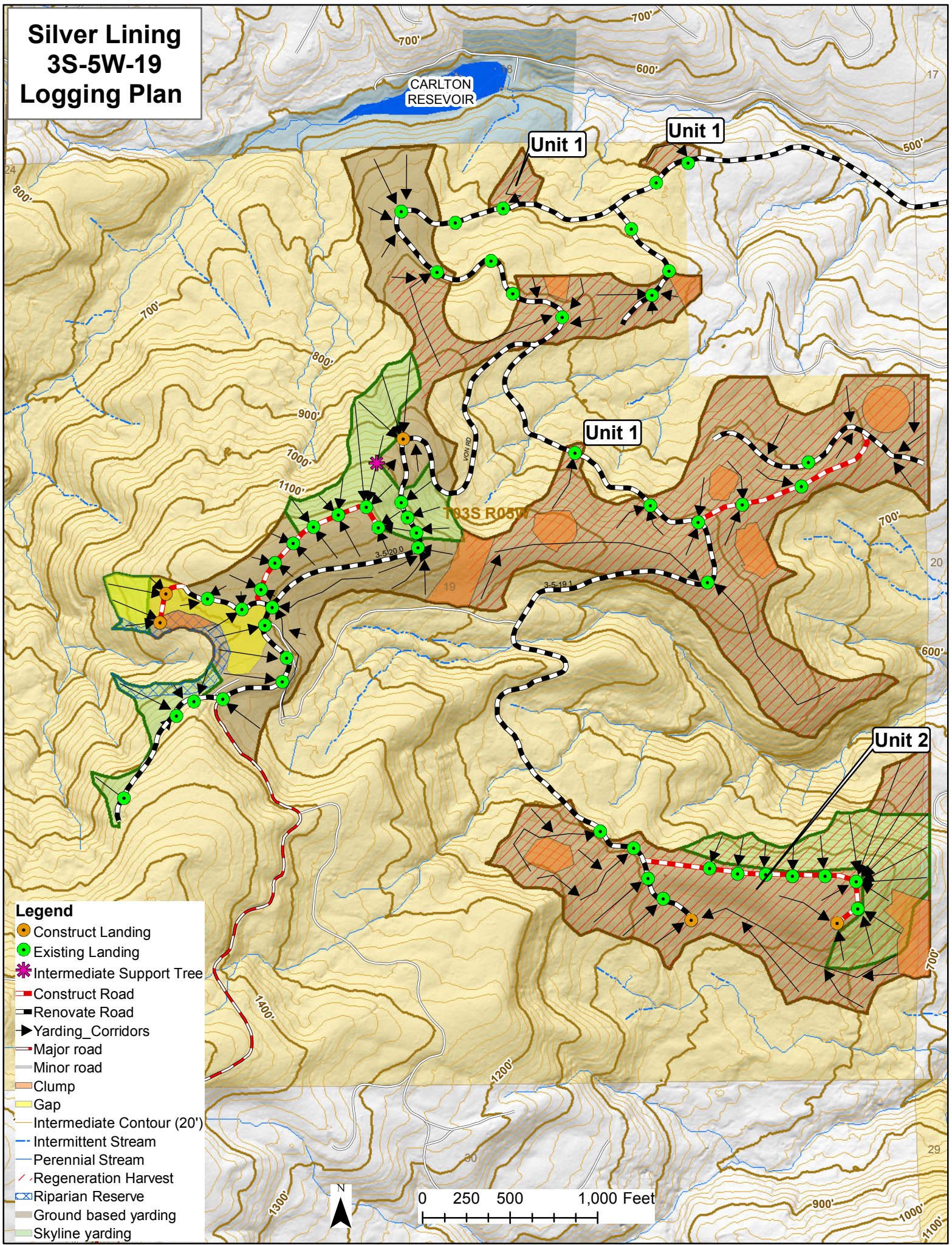

- Legend**
- Construct Landing
 - Existing Landing
 - Intermediate Support Tree
 - Construct Road
 - Renovate Road
 - Yarding_Corridors
 - Major road
 - Minor road
 - Clump
 - Gap
 - Intermediate Contour (20')
 - Intermittent Stream
 - Perennial Stream
 - Regeneration Harvest
 - Riparian Reserve
 - Ground based yarding
 - Skyline yarding

0 250 500 1,000 Feet



Silver Lining 3S-5W-29 Logging Plan

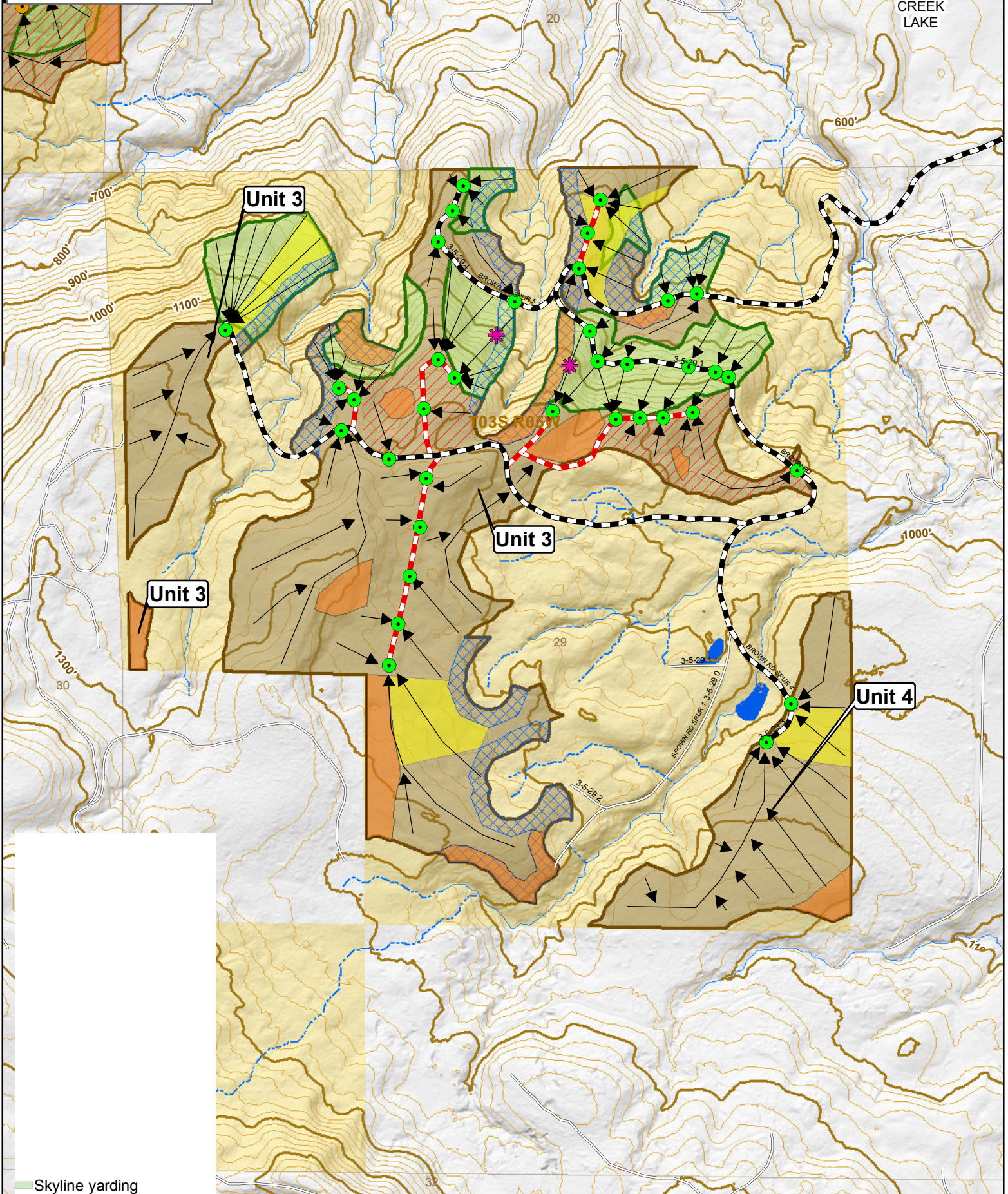

FALLS
CREEK
LAKE

Unit 3

03S R05N

Unit 3

Unit 3

Unit 4

Skyline yarding

Legal Description of Contract Area

Land Status	County	Township	Range	Section	Subdivision	Meridian
O&C	Yamhill	3 S	5 W	19	W1/2NE1/4, SE1/4NE1/4, E1/2NW1/4, SW1/4NW1/4, N1/2SW1/4, SE1/4	Willamette
O&C	Yamhill	3 S	5 W	29	W1/2NE1/4, NW1/4, NE1/4SW1/4, NW1/4SE1/4	Willamette

Species Totals

Species	Net	Gross Merch	Gross	# of Merch Logs	# of Cull Logs	# of Trees
Douglas Fir	8,155.0	8,442.0	8,732.0	112,090	1,460	31,814
Western Redcedar	370.0	392.0	392.0	3,560	0	689
Bigleaf Maple	63.0	93.0	93.0	1,369	932	827
Grandfir	26.0	26.0	26.0	577	0	144
Western Hemlock	20.0	21.0	21.0	589	0	196
Red Alder	5.0	9.0	9.0	91	155	86
Totals	8,639.0	8,983.0	9,273.0	118,276	2,547	33,756

Cutting Area Acres

Regeneration Harvest Acres	Partial Cut Acres	Right of Way Acres	Total Acres	Net Volume per Acre
126.0	166.0	5.0	297.0	29.1

Comments:

This is a scale sale

Logging Costs

Stump to Truck	\$643,963.13
Transportation	\$427,596.67
Road Construction	\$743,568.96
Maintenance/Rockwear	\$61,059.48
Road Use	\$0.00
Other Allowances	\$76,969.00
Total:	\$1,953,157.24
Total Logging Cost per MBF:	\$226.09

Utilization Centers

<u>Location</u>	<u>Distance</u>	<u>% of Net Volume</u>
Willamina	33.0 miles	95 %
Garibaldi	89.0 miles	1 %
Longview	85.0 miles	4 %

Profit & Risk

Profit	9 %
Risk	3 %
Total Profit & Risk	12 %

Tract Features

Quadratic Mean DBH	15.7 in
Average GM Log	76 bf
Average Volume per Acre	29.1 mbf
Recovery	93 %
<u>Net MBF volume:</u>	
Green	8,639.0 mbf
Salvage	0 mbf
Export	0 mbf
<u>Ground Base Logging:</u>	
Percent of Sale Volume	83 %
Average Yarding Slope	20 %
Average Yarding Distance	375 ft
<u>Cable Logging:</u>	
Percent of Sale Volume	17 %
Average Yarding Slope	60 %
Average Yarding Distance	333 ft
<u>Aerial Logging:</u>	
Percent of Sale Volume	0 %
Average Yarding Slope	0 %
Average Yarding Distance	0 ft

Cruise

Cruise Completed	June 2019
Cruised By	Mario Salmon
Cruise Method	Variable plot 20 BAF in thinning 40BAF in Regen and RW

Stumpage Computation

Species	# of Trees	Net Volume	Pond Value	(-) Profit & Risk	(-) Logging Costs	(+) Marginal Log Value	Appraised Price/MBF	Appraised Value
Douglas Fir	31,814	8,155.0	\$508.38	\$61.01	\$226.09	\$0.00	\$221.30	\$1,804,701.50
Western Redcedar	689	370.0	\$715.14	\$85.82	\$226.09	\$0.00	\$403.20	\$149,184.00
Bigleaf Maple	827	63.0	\$301.61	\$36.19	\$226.09	\$0.00	\$39.30	\$2,475.90
Grandfir	144	26.0	\$376.56	\$45.19	\$226.09	\$0.00	\$105.30	\$2,737.80
Western Hemlock	196	20.0	\$353.20	\$42.38	\$226.09	\$0.00	\$84.70	\$1,694.00
Red Alder	86	5.0	\$336.00	\$40.32	\$226.09	\$0.00	\$69.60	\$348.00
Totals	33,756	8,639.0						\$1,961,141.20

Other Wood Products

Product	Unit of Measure	# of Units	\$/Unit	Appraised Value
Marginal Logs	Green Tons	135	\$5.00	\$675.00
Totals				\$675.00

Total Appraised Value: \$1,961,816.20

Silver Lining**Unit Summary****ORN04-TS-2019.0402****Unit: 1**

Douglas Fir	3,157.0	3,274.0	3,411.0	10,711
Bigleaf Maple	30.0	44.0	44.0	391
Western Hemlock	10.0	10.0	10.0	92

Net Volume/Acre: 33.3 MBF

Partial Cut	39.0
Total Acres:	101.0

Unit: 2

Douglas Fir	1,632.0	1,697.0	1,788.0	4,267
Bigleaf Maple	20.0	29.0	29.0	259
Western Hemlock	6.0	6.0	6.0	62

Net Volume/Acre: 42.8 MBF

Partial Cut	0.0
Total Acres:	41.0

Unit: 3

Douglas Fir	3,158.0	3,256.0	3,307.0	16,263
Bigleaf Maple	11.0	16.0	16.0	145
Western Hemlock	3.0	4.0	4.0	35

Net Volume/Acre: 21.9 MBF

Partial Cut	127.0
Total Acres:	150.0

Unit: RW

Species	Net	Gross Merch	Gross	# of Trees
Douglas Fir	208.0	215.0	226.0	573
Western Redcedar	11.0	12.0	12.0	20
Red Alder	5.0	9.0	9.0	86
Bigleaf Maple	2.0	4.0	4.0	32
Western Hemlock	1.0	1.0	1.0	7
Grandfir	1.0	1.0	1.0	6
Totals:	228.0	242.0	253.0	724

Net Volume/Acre: 45.6 MBF

Partial Cut	0.0
Total Acres:	5.0

Comments:

some volumes were adjusted to match R705

Total Stump To Truck	Net Volume	\$/MBF
\$643,963.13	8,639.0	\$74.54

Stump to Truck: Falling, Bucking, Yarding, & Loading

Yarding System	Unit of Measure	# of Units of Measure	\$/Unit of Measure	Total Cost	Remarks
Cable: Medium Yarder	GM MBF	713.0	\$114.85	\$81,888.05	Cable Thinn
Cable: Medium Yarder	GM MBF	1,119.0	\$82.04	\$91,802.76	Cable Regen
Track Skidder	GM MBF	2,386.0	\$78.47	\$187,229.42	Ground Thinn
Track Skidder	GM MBF	4,765.0	\$58.86	\$280,467.90	Ground Regen
Subtotal				\$641,388.13	

Additional Costs

Item	Unit of Measure	# of Units of Measure	\$/Unit of Measure	Total Cost	Remarks
Intermediate Support	Each	3.0	\$275.00	\$825.00	
Subtotal				\$825.00	

Additional Moves

Equipment	Unit of Measure	# of Units of Measure	\$/Unit of Measure	Total Cost	Remarks
Cable: Medium Yarder	Each	1.0	\$800.00	\$800.00	
Shovel	Each	1.0	\$500.00	\$500.00	
Track Skidder	Each	1.0	\$450.00	\$450.00	
Subtotal				\$1,750.00	

Comments:

Fuel costs 3.00/gal.

5mbf/load

cable thin 5 loads/day

cable regen 7 loads/day

ground thin 6 loads/day

ground regen 9 loads/day

Total	Net Volume	\$/MBF
\$427,596.67	8,639.0	\$49.50

Utilization Center	One Way Mileage	Description	Unit of Measure	# of Units	\$/Unit of Measure	Total Cost	% of Sale Volume
Garibaldi	89.0	Hardwoods	GM MBF	93.0	\$118.75	\$11,043.75	1 %
Longview	85.0	Cedar	GM MBF	392.0	\$118.75	\$46,550.00	4 %
Willamina	33.0	Conifers	GM MBF	8,498.0	\$43.54	\$370,002.92	95 %

Comments:

Conifers: \$95/hr. 2.75hr/round trip 6mbf/load

Hardwoods: \$95/hr. 5hr/round trip 4mbf/load

Cedar: \$95/hr. 5hr round trip 4mbf/load

Engineering Allowances

Total	Net Volume	\$/MBF
\$804,628.44	8,639.0	\$93.14

Cost Item	Total Cost
Road Construction:	\$743,568.96
Road Maintenance/Rockwear:	\$61,059.48
Road Use Fees:	\$0.00

Total	Net Volume	\$/MBF
\$76,969.00	8,639.0	\$8.91

Environmental Protection

Cost item	Total Cost
Machine Washing	\$296.00
Subtotal	\$296.00

Logging

Cost item	Total Cost
Basal Girdle	\$2,256.00
Fell (CWD)	\$6,912.00
High Girdle	\$21,125.00
Saw-Top	\$23,730.00
Subtotal	\$54,023.00

Slash Disposal & Site Prep

Cost item	Total Cost
Landing pile cover	\$750.00
Landing pile burn	\$750.00
Machine pile burn	\$3,525.00
Machine pile construct/cover	\$17,625.00
Subtotal	\$22,650.00